

BUTLER COUNTY HISTORY

OR
"I NEVER IMAGINED SO MUCH COOL STUFF HAPPENED IN BUTLER!"

WRITTEN BY
TERI LYNN BOTTLES

ILLUSTRATED BY
UNCLE MIKE '00

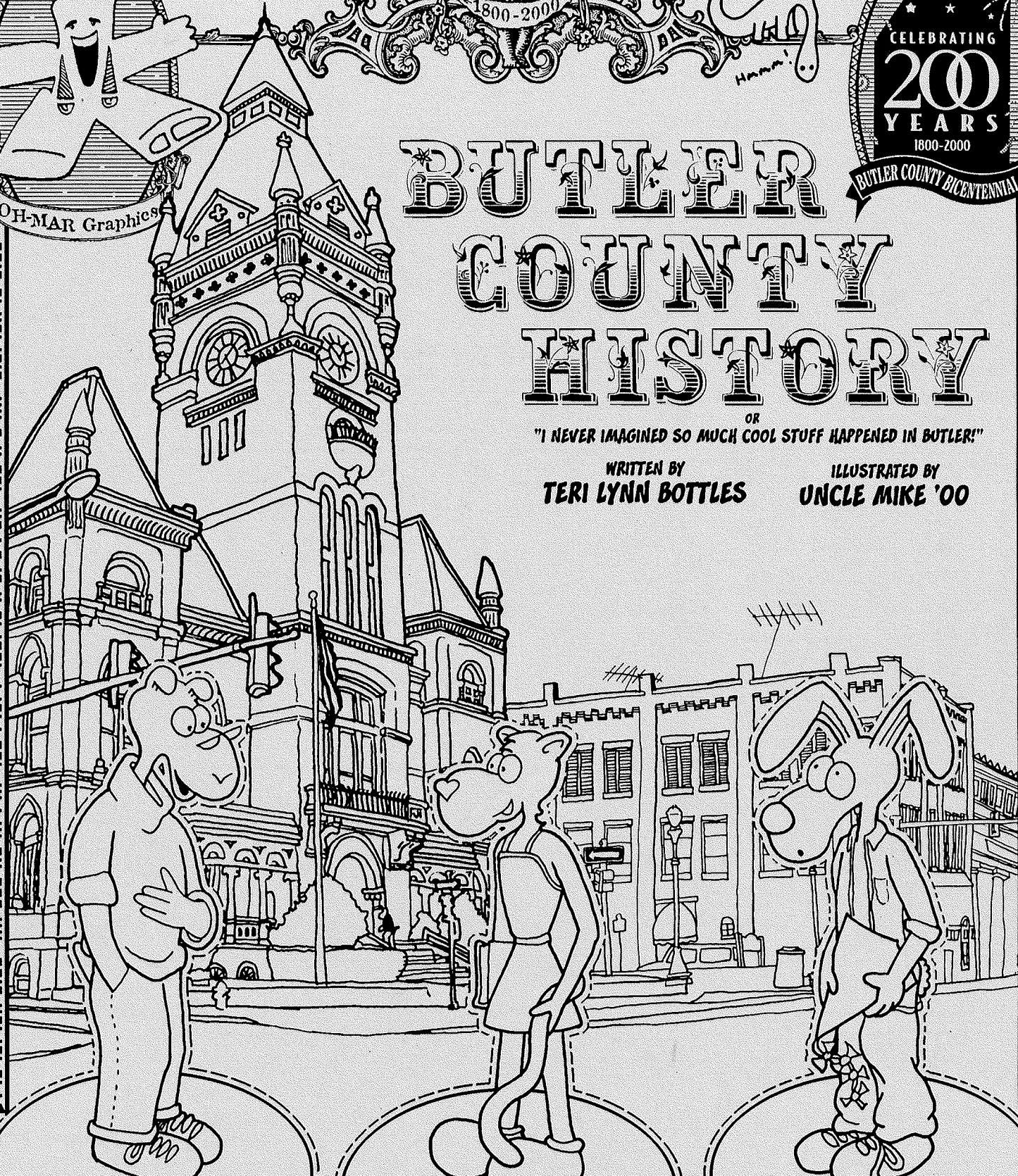

Kermit

Gabbie

Wendell

Kermit's Doll Stand

Gabbie's Doll Stand

Wendell's Doll Stand

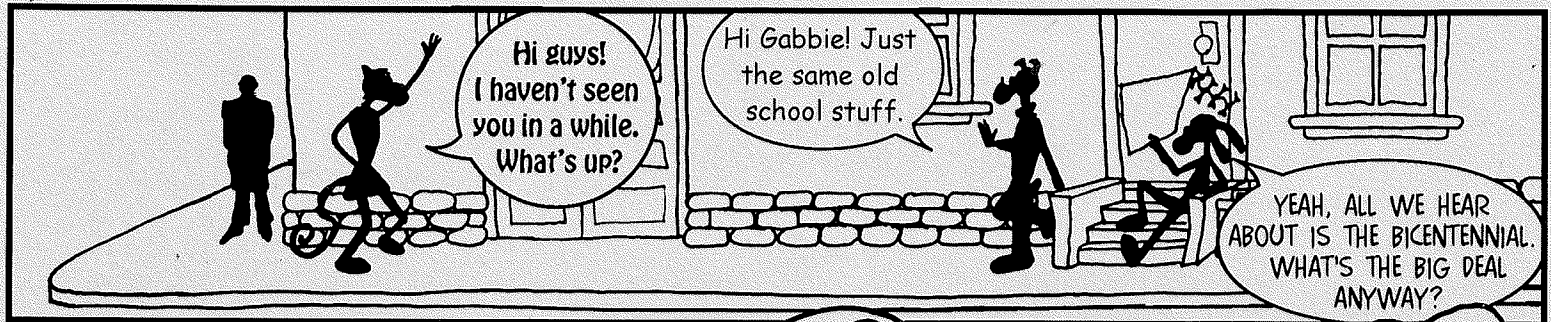

Hi guys! I haven't seen you in a while. What's up?

Hi Gabbie! Just the same old school stuff.

YEAH, ALL WE HEAR ABOUT IS THE BICENTENNIAL. WHAT'S THE BIG DEAL ANYWAY?

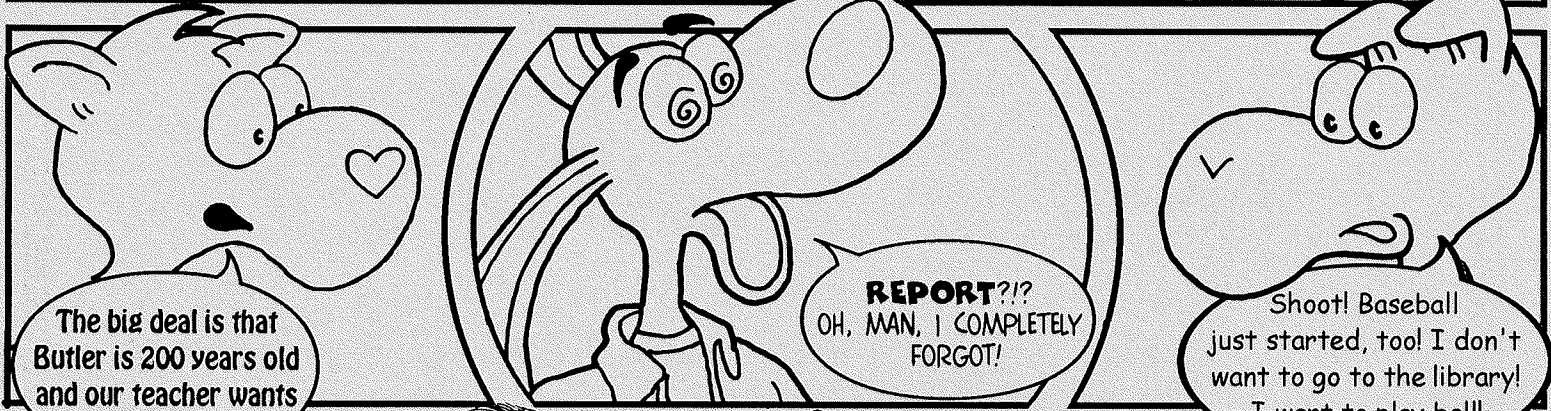

The big deal is that Butler is 200 years old and our teacher wants a report.

REPORT?!? OH, MAN, I COMPLETELY FORGOT!

Shoot! Baseball just started, too! I don't want to go to the library! I want to play ball!

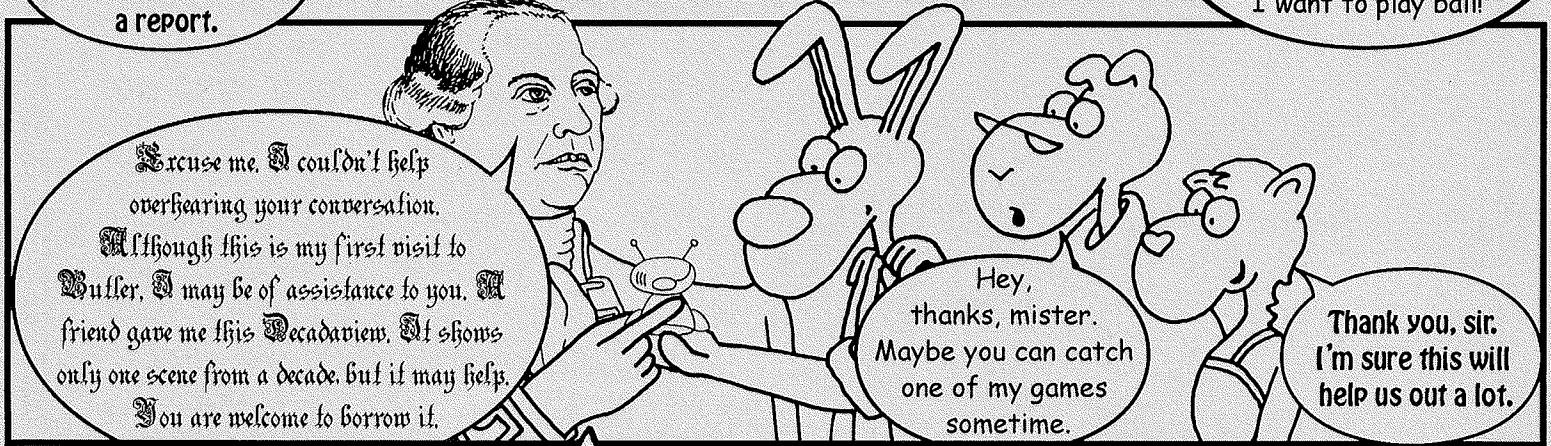

Excuse me. I couldn't help overhearing your conversation. Although this is my first visit to Butler, I may be of assistance to you. A friend gave me this Decadaview. It shows only one scene from a decade, but it may help. You are welcome to borrow it.

Hey, thanks, mister. Maybe you can catch one of my games sometime.

Thank you, sir. I'm sure this will help us out a lot.

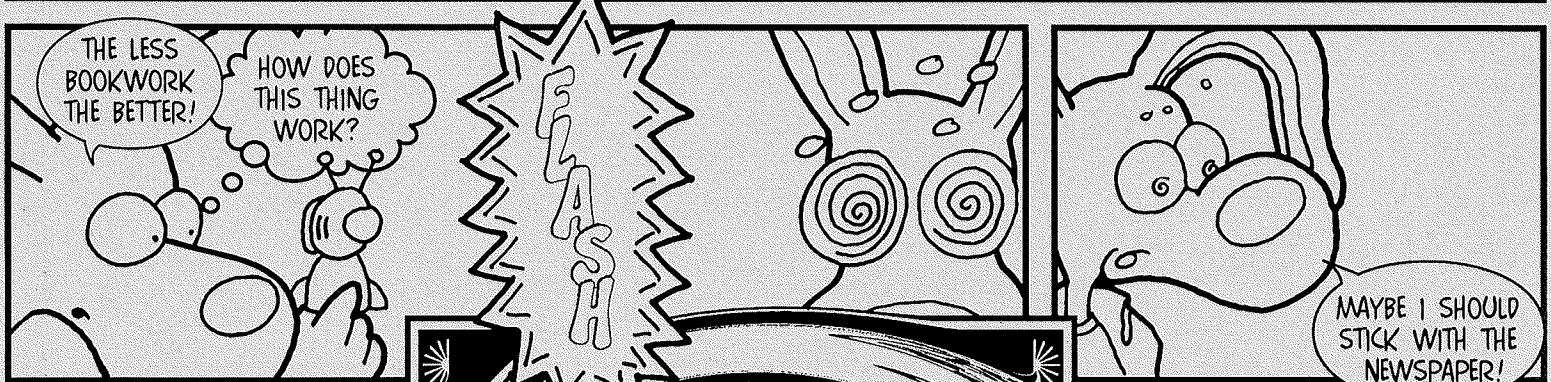

THE LESS BOOKWORK THE BETTER!

HOW DOES THIS THING WORK?

FLASH

MAYBE I SHOULD STICK WITH THE NEWSPAPER!

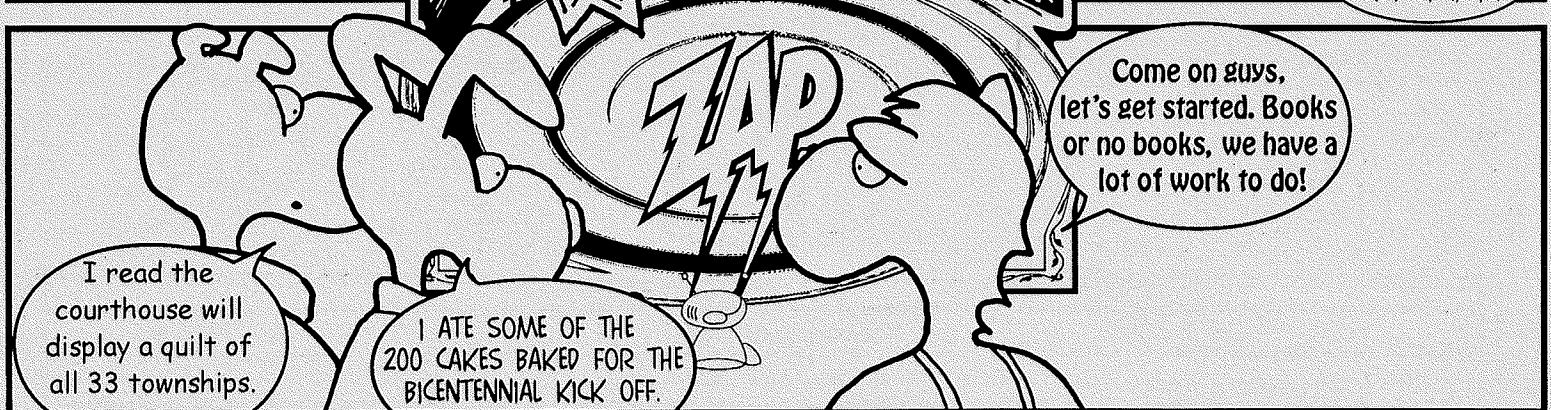

I read the courthouse will display a quilt of all 33 townships.

I ATE SOME OF THE 200 CAKES BAKED FOR THE BICENTENNIAL KICK OFF.

Come on guys, let's get started. Books or no books, we have a lot of work to do!

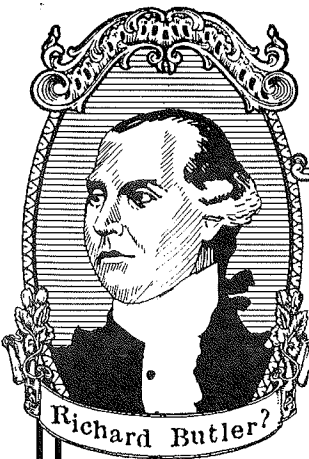

Richard Butler?



1700's

You can use these costumes on the paper dolls on the cover!

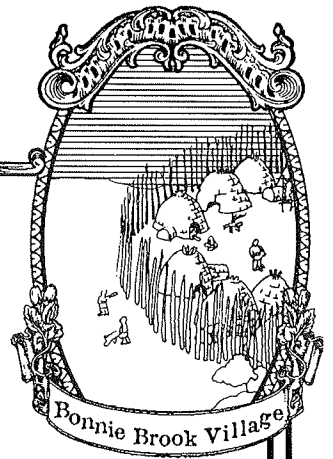

Bonnie Brook Village

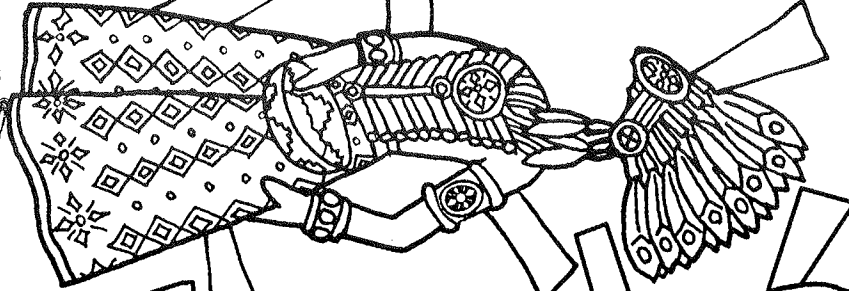

While traveling through Butler on December 27, 1753, George Washington's Indian guide turned and shot at him. He missed. Washington retrieved the gun from the guide and sent him home.

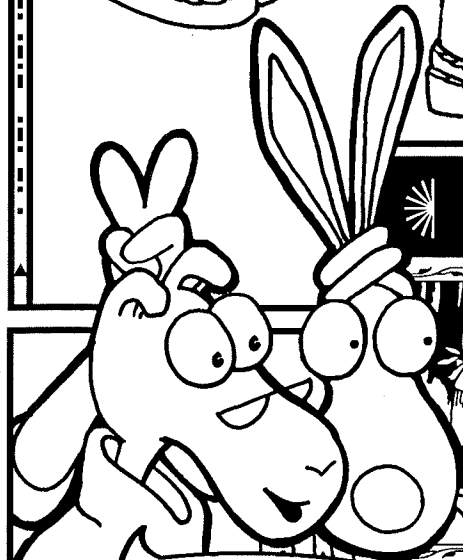

I read that Butler had Seneca, Mohawk, Oneida, Onondaga, Coyuga, and Tuscarora Indians.

YEAH, SOME OF THEM MUST HAVE BEEN REAL MEANIES. THEY KIDNAPPED MASSY HARBISON.

HOW!

Behave, Wendell! She and her crying baby did escape.

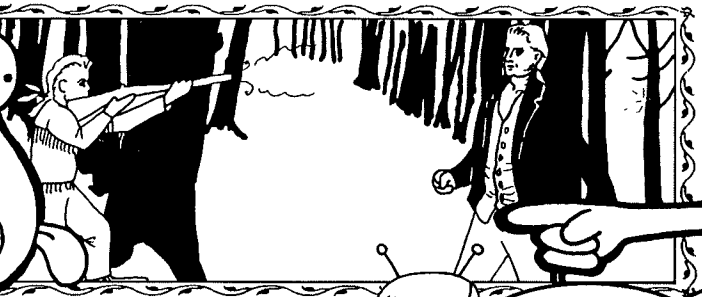

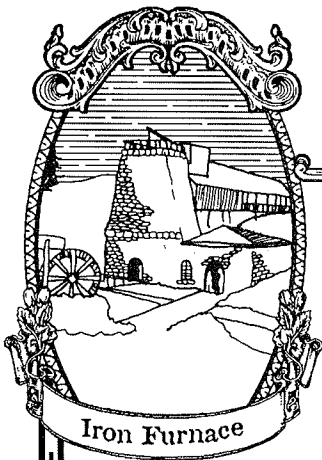

Iron Furnace



Help me find all 33 townships hidden below!



Thomas Butler?

FIRST 4 TOWNSHIPS

BUFFALO
MIDDLESEX
SLIPPERY ROCK
CONNOQUENESSING

1804 - NINE NEW TOWNSHIPS ADDED

MERCER
CENTER
PARKER
BUTLER
DONEGAL
VENANGO
CLEARFIELD
CRANBERRY
MUDDY CREEK

T	B	K	C	O	R	Y	R	E	P	P	I	L	S	Q	D
N	O	O	N	O	T	G	N	I	H	S	A	W	O	C	R
M	O	C	R	A	N	B	E	R	R	Y	G	L	O	C	E
U	V	T	F	A	I	R	V	I	E	W	A	N	O	A	K
D	C	E	N	T	E	R	E	T	Y	F	N	N	E	L	R
D	R	D	N	I	W	H	N	A	F	O	C	F	X	L	A
Y	E	L	O	A	L	F	L	U	Q	O	D	O	E	E	P
C	T	E	I	D	N	C	B	U	R	N	T	R	S	G	P
R	S	I	R	A	D	G	E	D	A	I	B	W	E	H	E
E	A	F	A	M	S	N	O	L	M	F	U	A	L	E	N
E	C	N	M	S	E	K	K	M	A	O	T	R	D	N	N
K	N	I	T	S	W	A	U	L	R	G	L	D	D	Y	M
O	A	W	S	N	O	S	K	C	A	J	E	E	I	B	E
M	L	I	F	R	A	N	K	L	I	N	R	N	M	R	R
O	N	N	N	O	S	R	E	F	F	E	J	C	O	A	C
G	C	L	E	A	R	F	I	E	L	D	X	T	I	D	E
H	T	R	O	W	N	G	L	E	C	H	E	R	R	Y	R

CLAY
PENN
BRADY
ADAMS
WORTH
CHERRY
SUMMIT
MARION
CLINTON
FAIRVIEW
WINFIELD
JACKSON
OAKLAND
FRANKLIN
FORWARD
CONCORD
LANCASTER
JEFFERSON
ALLEGHENY
WASHINGTON

(CURRENTLY THERE ARE 33 TOWNSHIPS IN BUTLER COUNTY)

Big John McJunkin caused a stir in a rented courtroom. The judge held him in contempt and ordered Big John thrown in jail.

On March 12, 1800, Butler County was formed by an act of legislation with these provisions: 1. It had four townships. 2. It was attached to Allegheny County for administrative purposes.

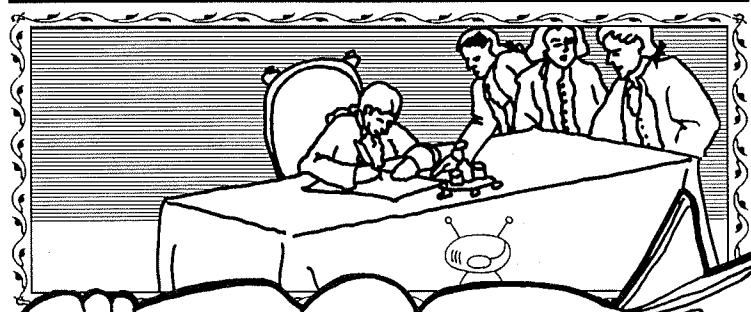

At least he escaped! Poor Ann Girty was shot because someone said she was a witch.

THEY DIDN'T HAVE A JAIL YET, SO THEY USED BOWEN'S EMPTY PIGPEN! BIG JOHN ESCAPED INTO THE HAZEL BUSHES.





David Dougal



cardboard container



large rubber band



tape



20 pennies



toothpicks

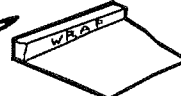

plastic wrap

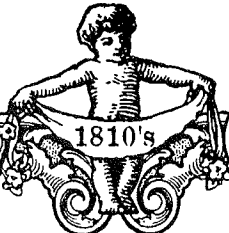

1810's

Just like a stagecoach, this toy will come back to you!

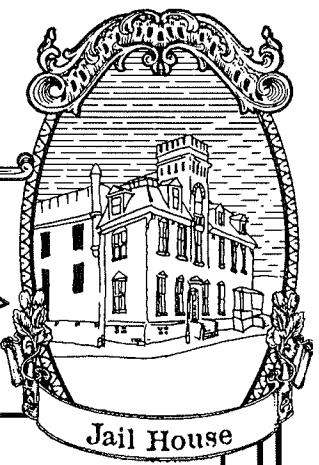

Jail House

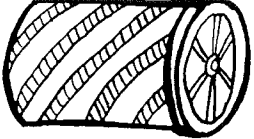

Decorate the container. (an oatmeal box works well)

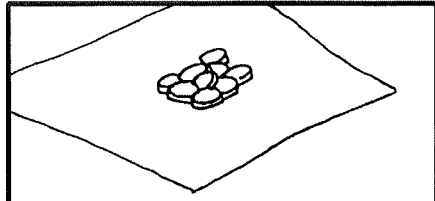

Put 20 pennies in center of a 12" square of plastic wrap.



Make into a bag and tie in the center of the rubber band.

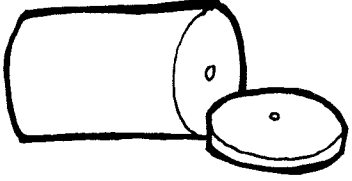

Poke holes in the center of the bottom and the lid.

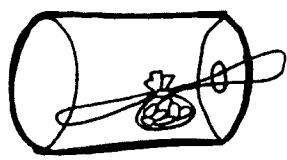

Push one end of the rubber band through the bottom of the canister.

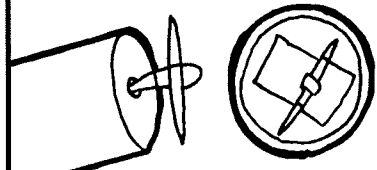

Slide a toothpick through and tape in place.

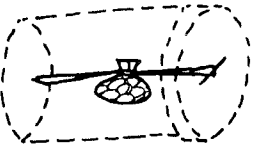

Repeat steps 5 & 6 for lid. Pennies must hang inside. (suspended in center)

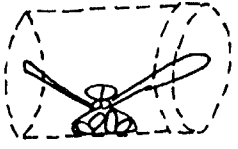

Adjust by changing the number of pennies or making more knots around bag.

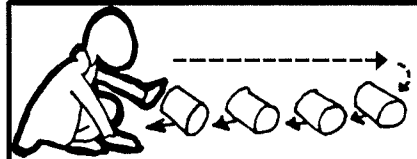

Roll the can away from you on a smooth, hard floor, and it will come back to you.

In 1810, a stagecoach route was established between Butler and Pittsburgh. The coach was a faster, safer means to transport mail, goods and people. Prior to the railroad, it was the only means of cross-country travel, and it continued to serve areas the railroad could not reach.

It was too far to walk or go by horse. People were excited to go on the stagecoach.



BUTLER PROTECTS COMMODORE PERRY



WHO CARES ABOUT A TRIP, GABBIE? PEOPLE WERE BUSY HUNTING SQUIRRELS SO THEY COULD SELL 2 SCALPS FOR 3 CENTS. WHAT A DEAL!

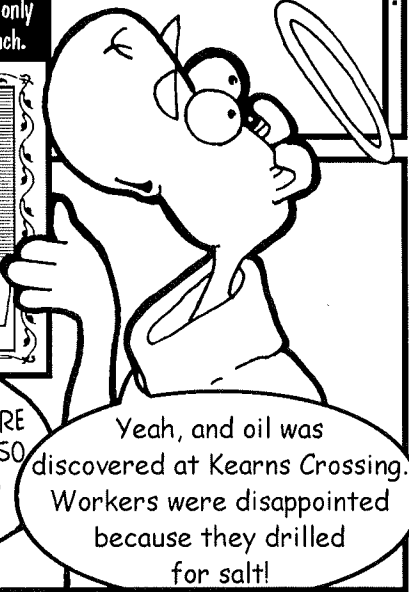

Yeah, and oil was discovered at Kearns Crossing. Workers were disappointed because they drilled for salt!

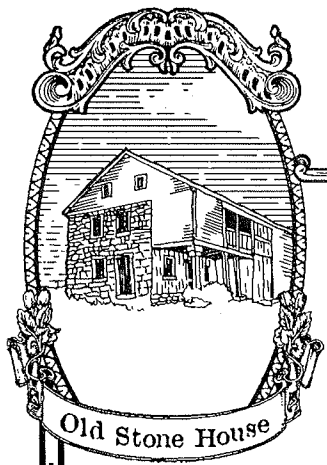

Old Stone House

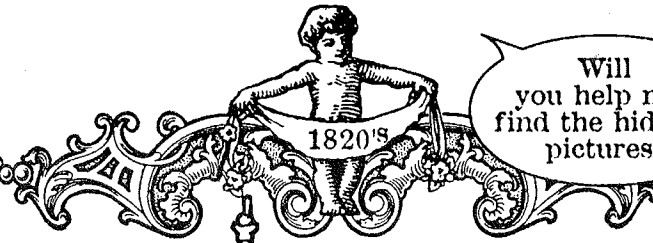

Will you help me find the hidden pictures?

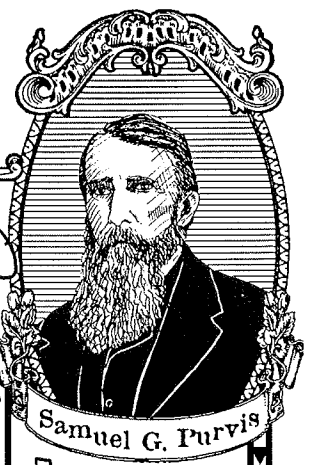

Samuel G. Purvis

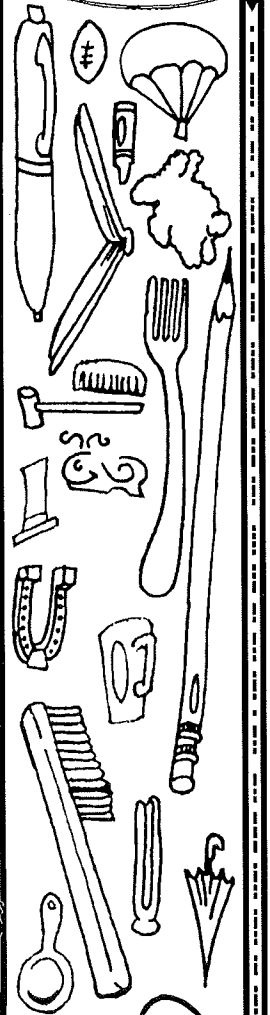

A Pennsylvania law said you couldn't have two wives, but it didn't say anything about having three!

In 1826, the following ordinances were passed in Butler:

- No ball playing against the Courthouse
- Firing guns in the borough is prohibited
- Blacksmith & carpenter shops must be 60 feet away from Main & Diamond St.
- All horses, cows, pigs and sheep straying on Main Street will be impounded

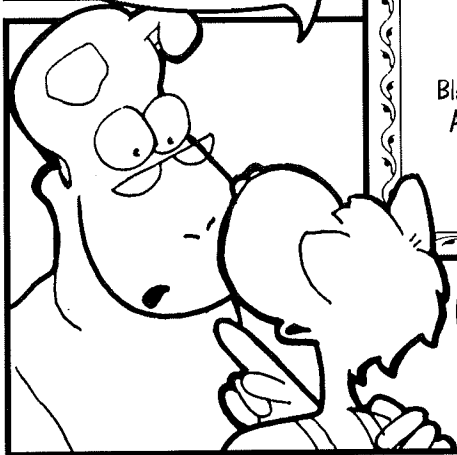

Geez, Kermit, maybe that's why Butler needed seven lawyers!

MY DAD SAYS ONE WIFE IS ENOUGH ! I HEARD A KID GOT KICKED BY A HORSE AND HIS BRAINS CAME OUT! THE DOCTOR FIXED HIM ON A KITCHEN TABLE AND HE HEALED COMPLETELY.



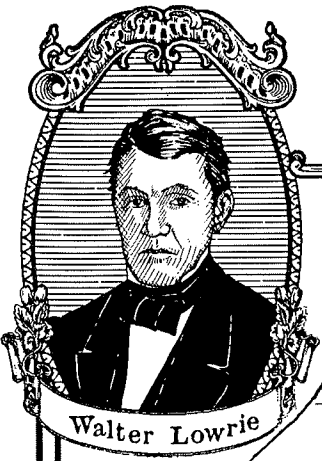

Walter Lowrie



1830's

Can you make it through this maze and avoid the Bounty Hunters?

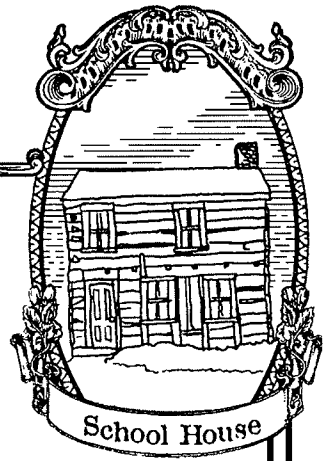

School House

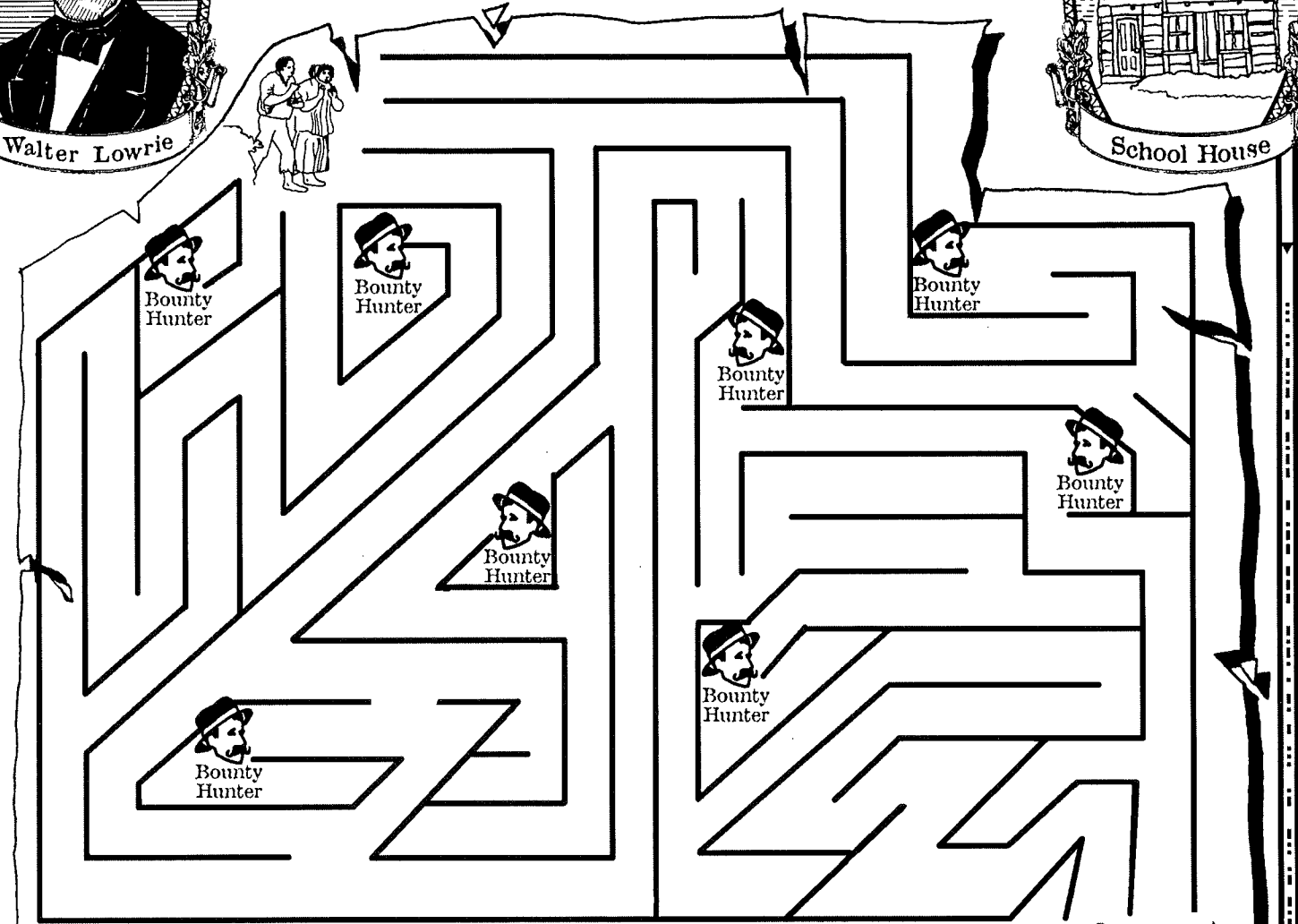

Bounty Hunter



Bounty Hunter



Bounty Hunter



Bounty Hunter



Bounty Hunter



Bounty Hunter



Bounty Hunter



Bounty Hunter



One of those "conductors" was Reverend Loyal Young

The underground railroad used railroad terms to define routes < lines > stops < stations > and people < conductors > Sympathetic northerners helped slaves escape to the promised land of Canada.

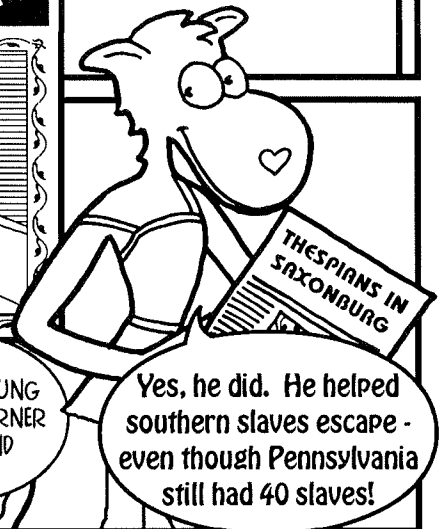
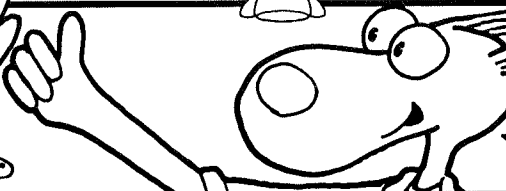

THE SPIRITS IN SAXONBURG

GABBIE, DIDN'T REV. YOUNG LIVE ON THE CORNER OF PEARL AND MONROE?

Yes, he did. He helped southern slaves escape - even though Pennsylvania still had 40 slaves!

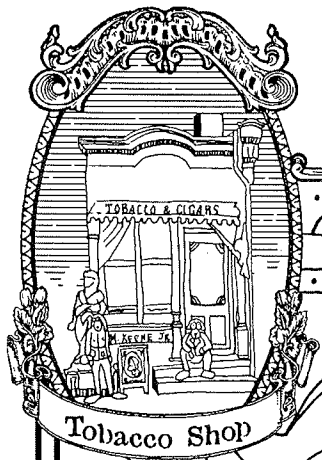

Tobacco Shop



1840's

See what you can find once you blacken the shapes that have dots in them.

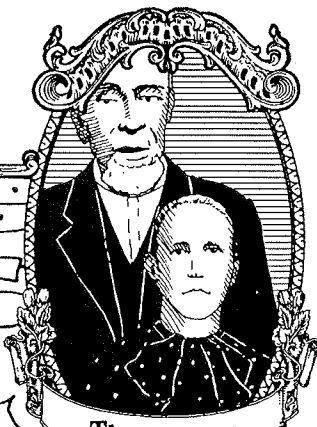

The Holmes

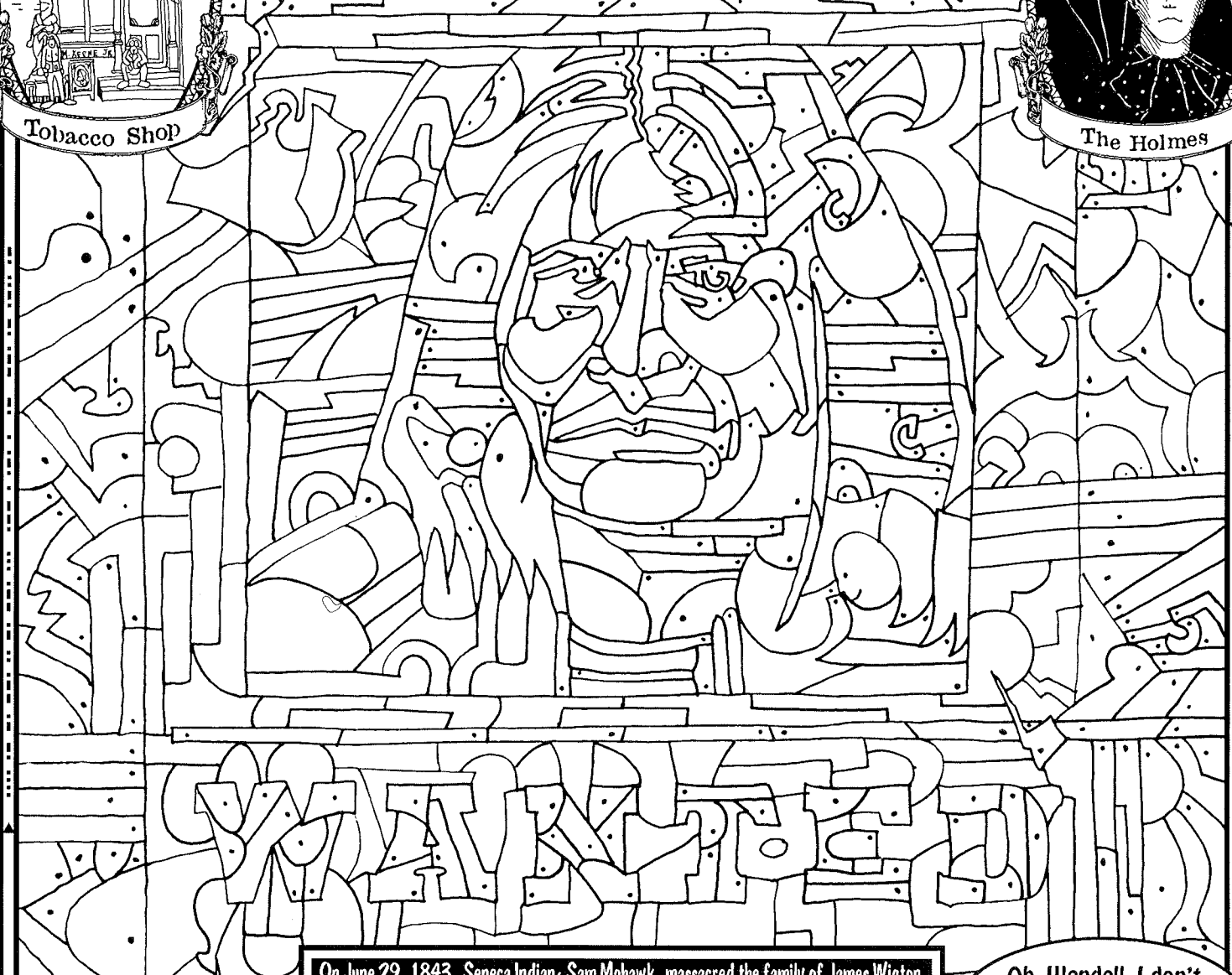

On June 29, 1843, Seneca Indian Sam Mohawk, massacred the family of James Wigton. He was the first person in Butler County to be sentenced to death. "Mohawk Sam" was hung on March 22, 1844; thousands viewed his body at the county courthouse.

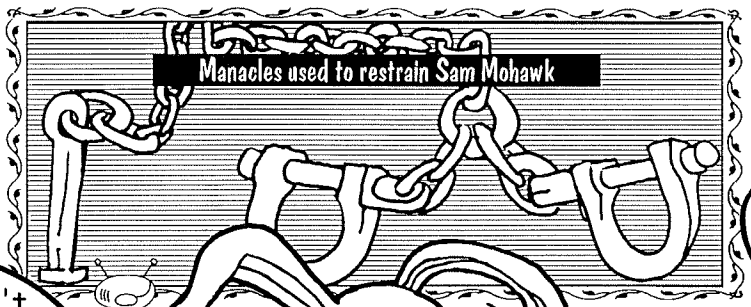

Manacles used to restrain Sam Mohawk

Oh, Wendell, I don't know! Many people left for the Gold Rush and probably forgot all about him.

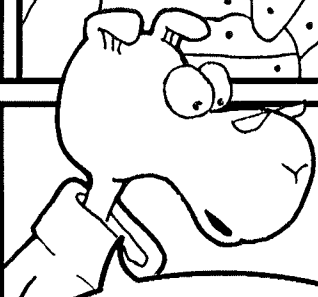

Since criminals weren't allowed to be buried in the cemetery, Sam Mohawk was buried in an unmarked grave on East Fulton Street.

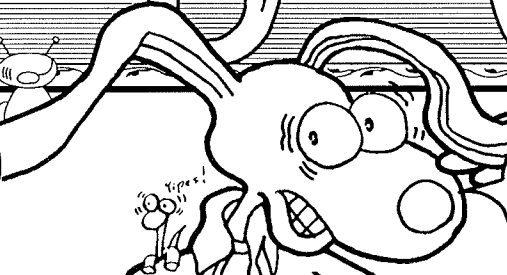

OOOOO CREEPY! DOES THAT MEAN HE'S STILL THERE?



HARMONY INN HAUNTED

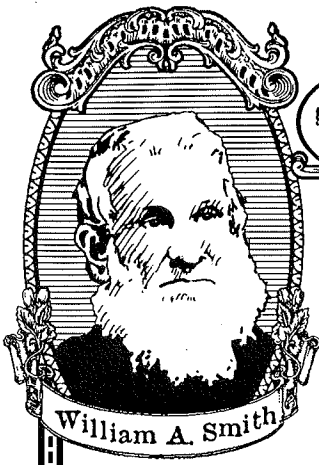

Cut out strips and glue them together. Have a parent cut the slits on the dotted lines.



Lace the strip through the slits, and it will look like odd things are coming out of the well!

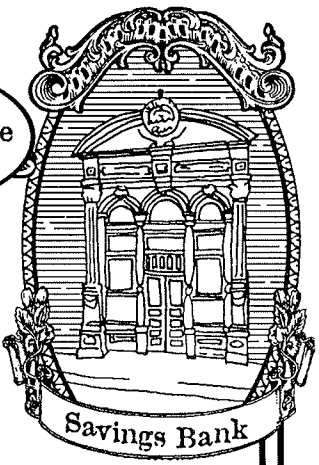

On August 27, 1859, William A. "Uncle Billy" Smith was the driller of the world's first producing oil well. He was hired by Colonel Edwin Drake to drill an oil well in Titusville. This well was the beginning of the oil boom in Butler County which led to the founding of the earliest oil companies.

--- cut here ---

--- cut here ---

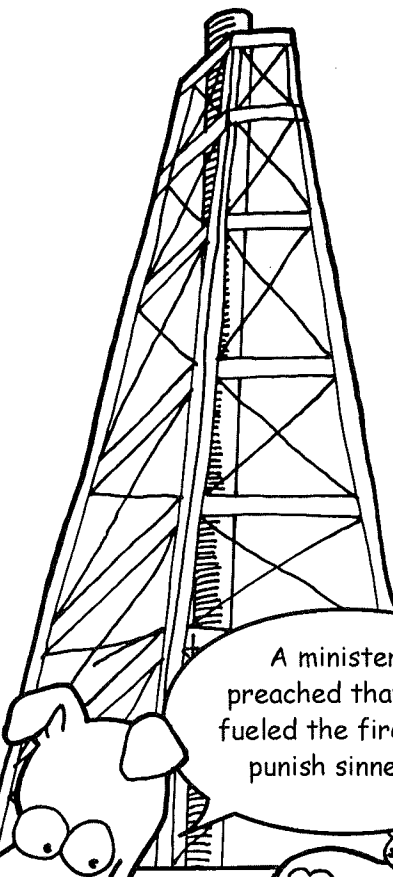
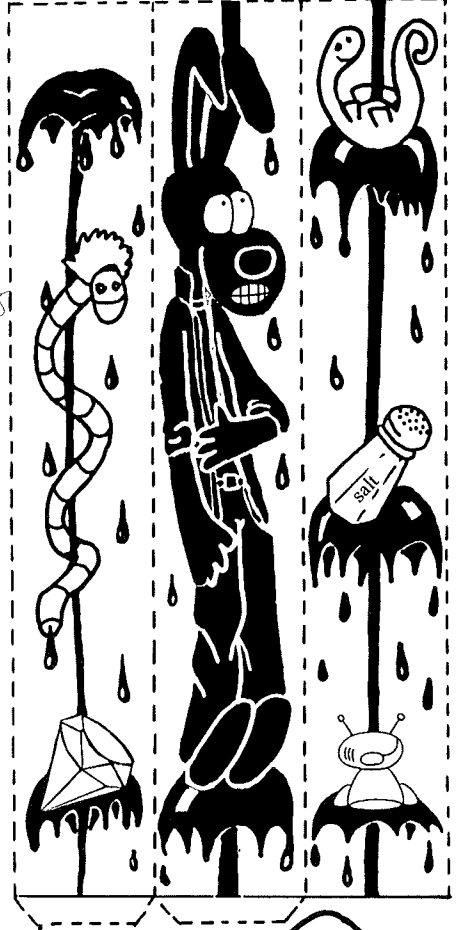

A minister preached that oil fueled the fires to punish sinners.

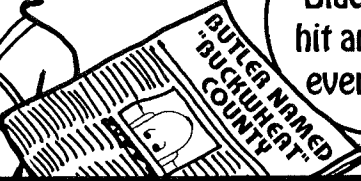

Then the "Black Frost" hit and killed everything!

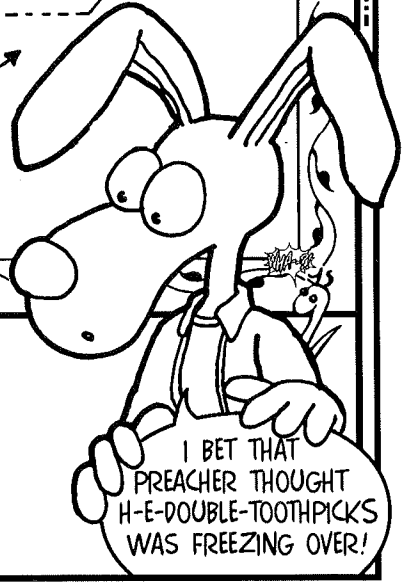

I BET THAT PREACHER THOUGHT H-E-DOUBLE-TOOTHPICKS WAS FREEZING OVER!

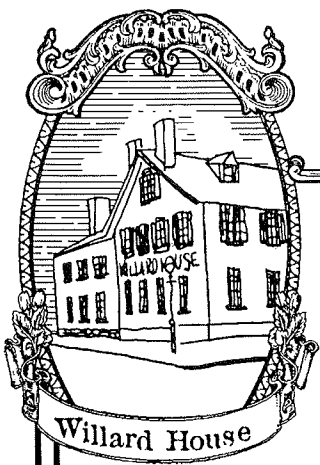

Willard House



1860's

Build your own telegraph line!

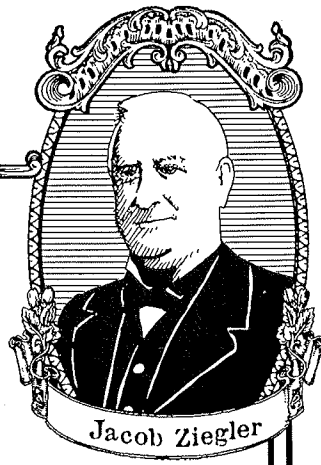

Jacob Ziegler

Morse Code

A	--	H	O	---	V
B	I	..	P	----	W	----
C	----	J	----	Q	----	X	----
D	---	K	---	R	---	Y	----
E	.	L	S	...	Z	----
F	M	--	T	-		
G	---	N	--	U	---		

The electromagnetic coil consists of one of the iron nails with at least 100 turns of copper wire wound neatly around it.

2 large IRON nails
(About 2-3 inches long)

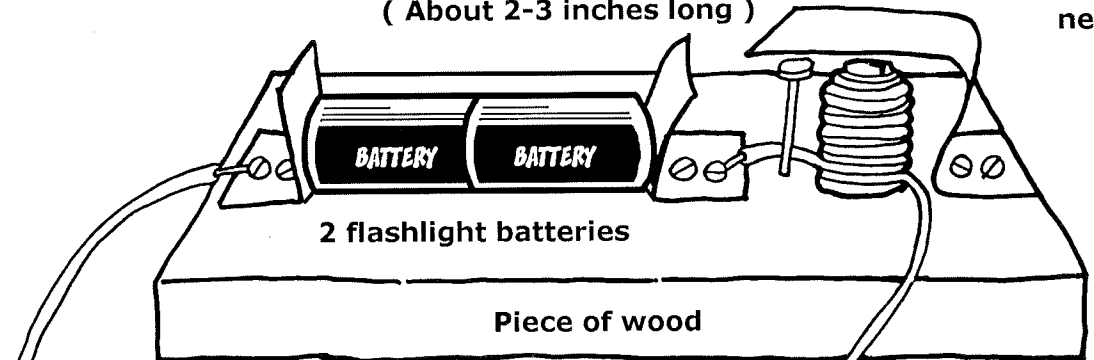

2 flashlight batteries

Piece of wood

4 Flat strips of metal
(Must be IRON- bearing or "Ferrous" Metal)

20 feet or more of
INSULATED copper wire
(18 - 28 gauge, about 1/32
inch or less in diameter)

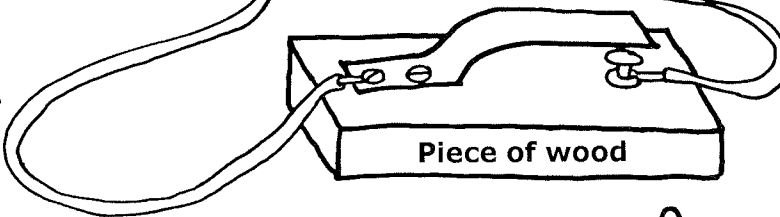

Piece of wood

Rev.
Richard C. Christy
was their fighting
chaplain.

Patriotism ran high in Butler at the start of the Civil War.
The initial quota of 75,000 men was immediately met with
volunteers to spare, and the Butler County Blues were formed.



It was during
the Civil War that
photography was
developed, too.

DON'T FORGET ABOUT
THE TELEGRAPH LINE
CONNECTING FRANKLIN
AND PITTSBURGH

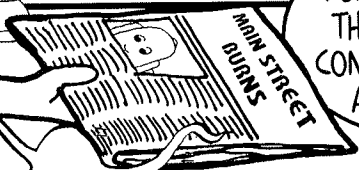



Ben Hogan

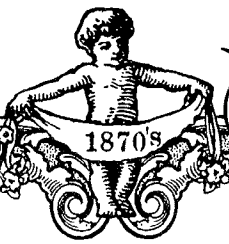

1870's

Which trains are exactly alike?

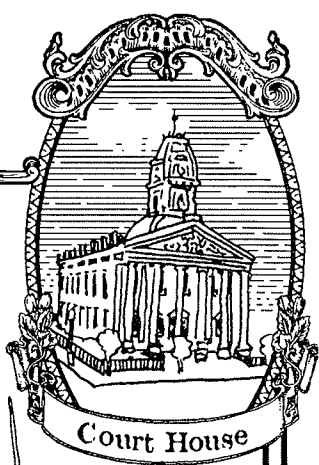

Court House

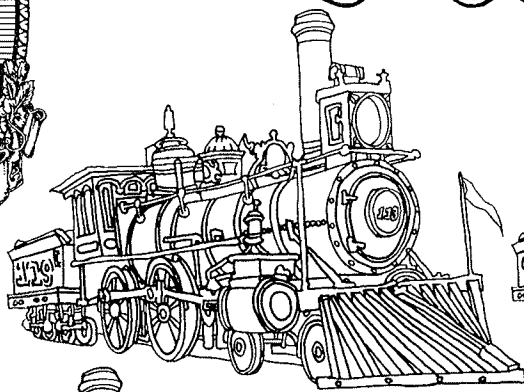

A

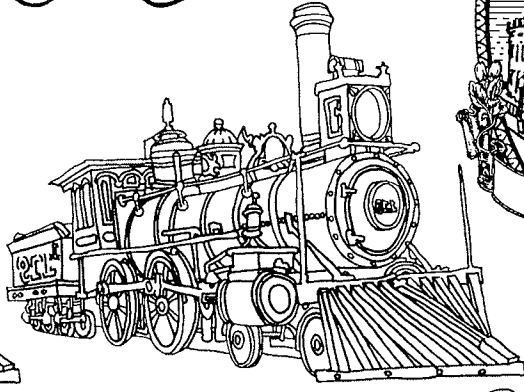

B

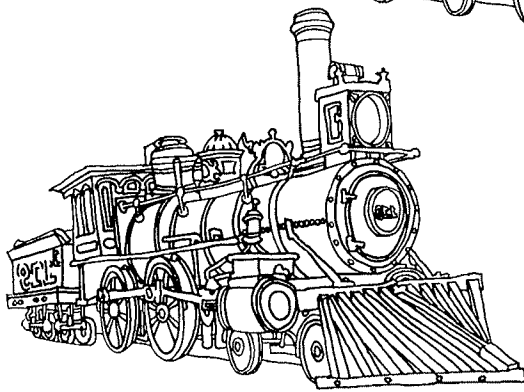

C

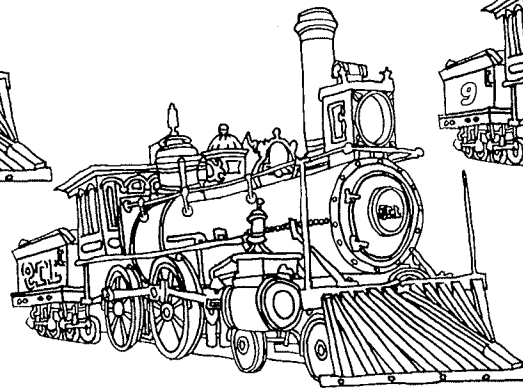

D

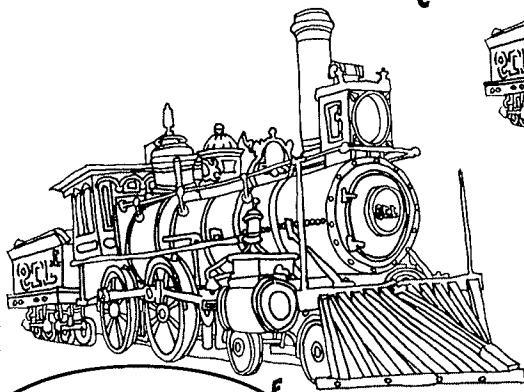

E

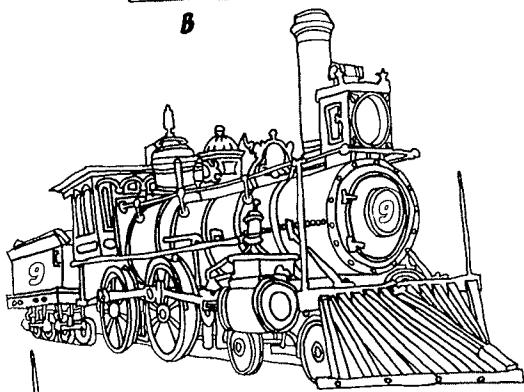

F



OUCH!

A mock funeral was held for the stagecoach when the railroad came to town.

With the coming of the railroad in January, 1871, the borough of Butler was on its way to becoming a major city. Over the next 32 years, rail transportation between Butler and Pittsburgh expanded to 76 cars daily.

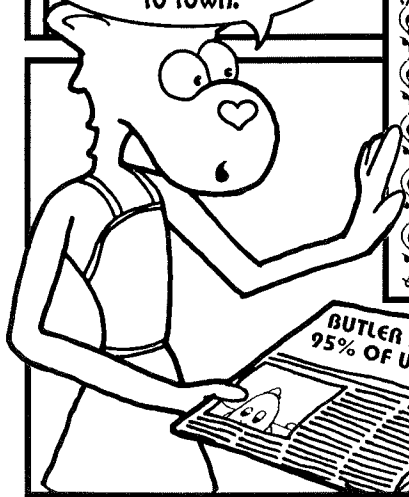
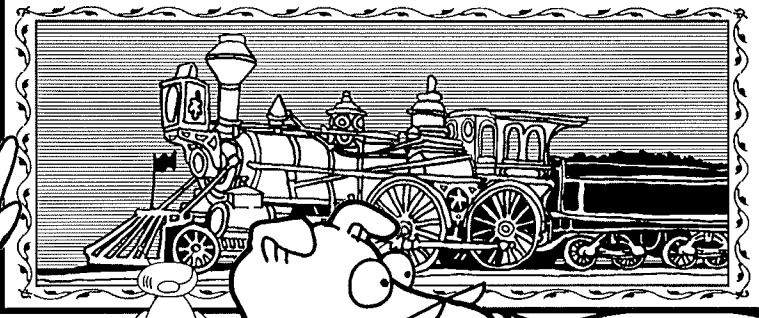

BUTLER PRODUCES 95% OF U.S. OIL

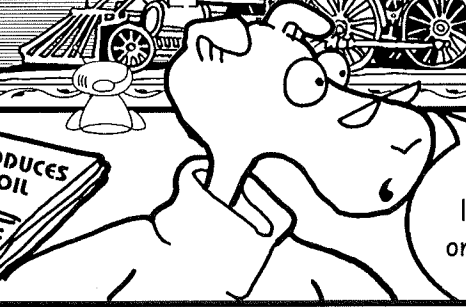

Ripley's Believe It or Not listed Evans City as the only station in the country built over water.



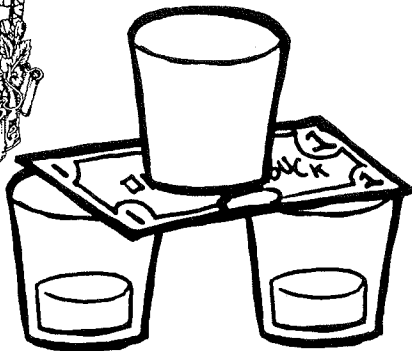
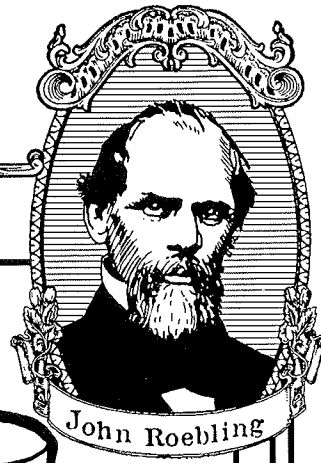
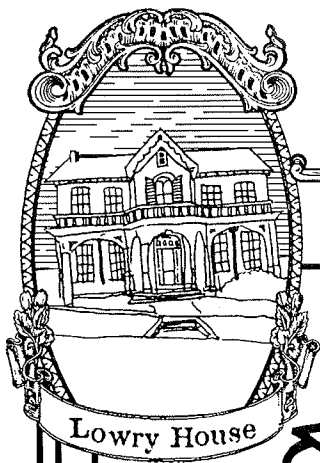

Bet somebody you can balance a glass on a dollar bill between two glasses.



Let them try and fail.

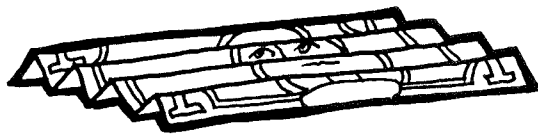

Fold the dollar bill like this (accordion fashion).

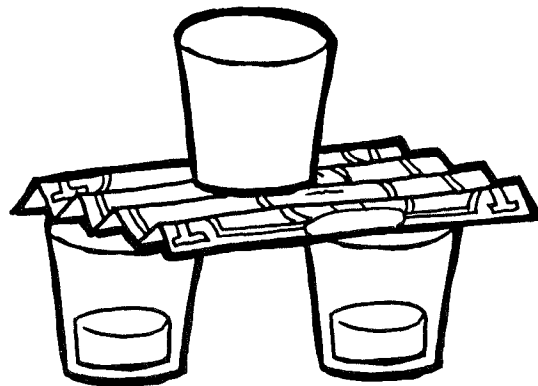

Set the glass on top of the bill like this and win the bet!

Butler has its own suspension bridge at the end of West Diamond Street

 John Roebling, the founder of Saxonburg, created a strong wire rope by hand. He is internationally known as the designer and builder of the Brooklyn Bridge that was completed on May 19, 1883.

Speaking of diamonds, rich oil families gave diamonds and pearls as party favors.



A GOLDEN EAGLE WITH A 7 FOOT WING SPAN WAS FOUND IN PENN TOWNSHIP.



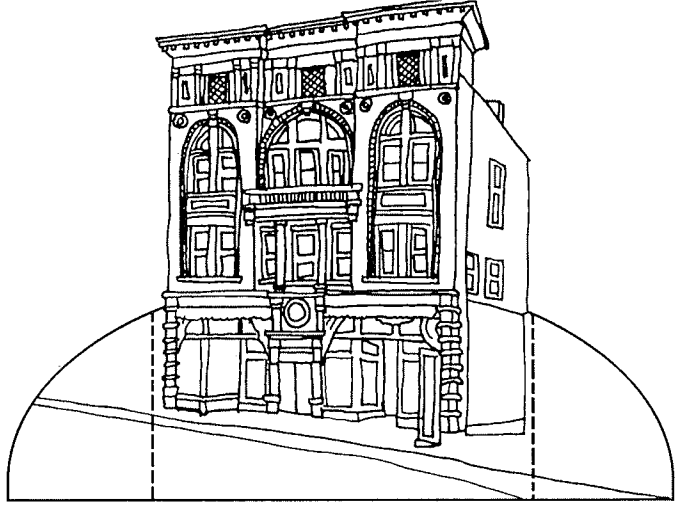
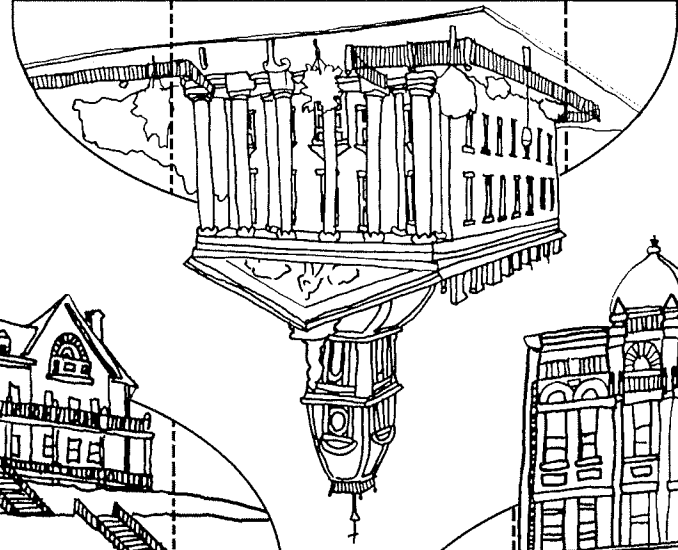
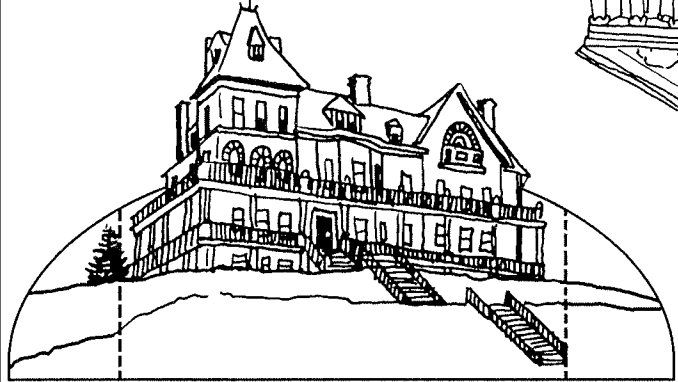
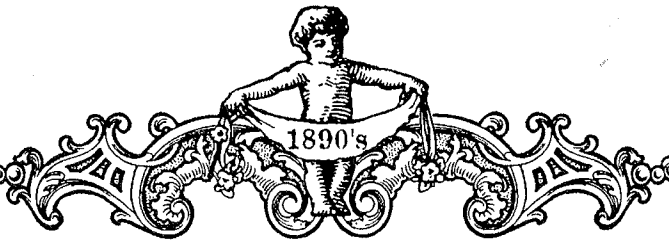

Main Street gained modern improvements:

- Roads paved
- Sewers installed
- Carbon electric lights added
- Soldiers Monument dedicated in Diamond Park



Did you ever hear the rumor about a copper box hidden in the Soldiers Monument?

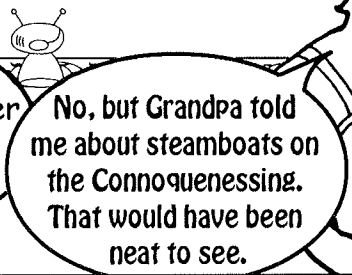

No, but Grandpa told me about steamboats on the Connoquenessing. That would have been neat to see.

RAIN MIGHT BE GOOD FOR STEAMBOATS, BUT TOO MUCH RAIN AND TORN UP ROADS MADE A SEA OF MUD. A HORSE GOT STUCK AND DIED!



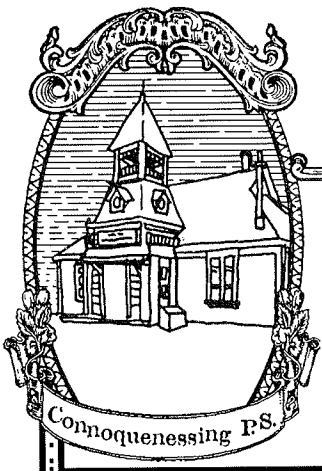

There is a lot to see in the picture below!



Over 7,000 people attended the opening of Alameda Park on July 4, 1901. Attractions included: Ferris wheel, roller coaster, dodge-em cars, carousel, swimming pool, roller skating rink/dance hall, and summer theater. Well known entertainers Louis Armstrong, Fletcher Henderson and King Oliver all performed at Alameda.

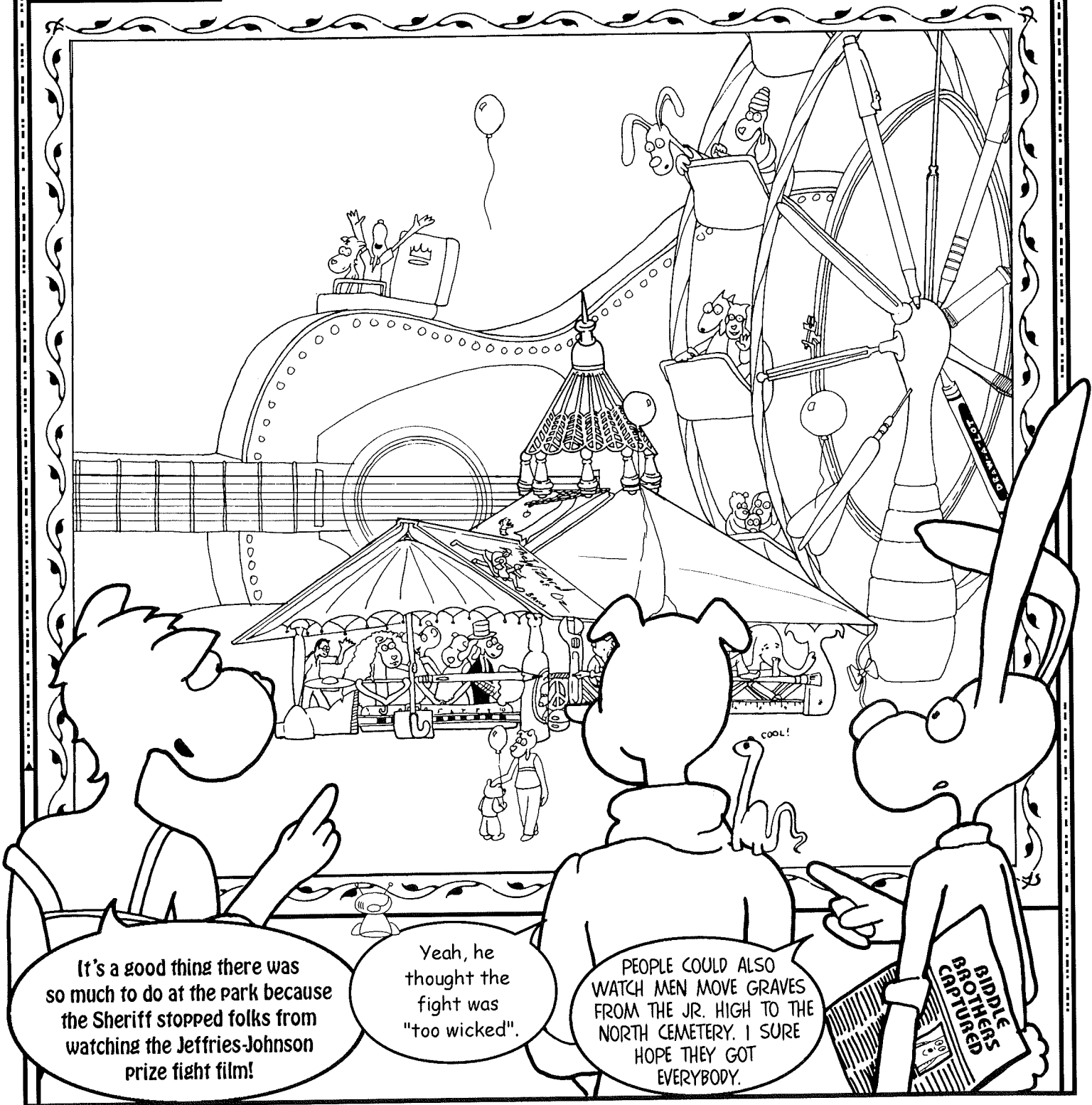

It's a good thing there was so much to do at the park because the Sheriff stopped folks from watching the Jeffries-Johnson prize fight film!

Yeah, he thought the fight was "too wicked".

PEOPLE COULD ALSO WATCH MEN MOVE GRAVES FROM THE JR. HIGH TO THE NORTH CEMETERY. I SURE HOPE THEY GOT EVERYBODY.





George M. Verity



1910's

You can use these costumes on the paper dolls on the cover!

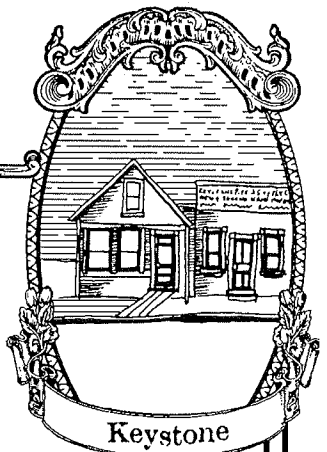

Keystone

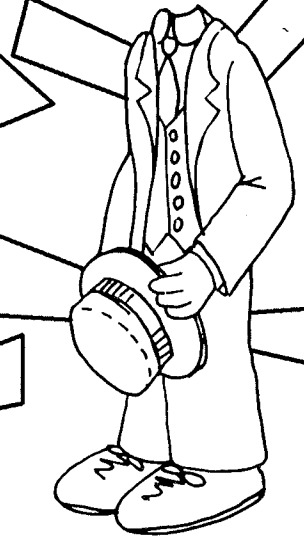
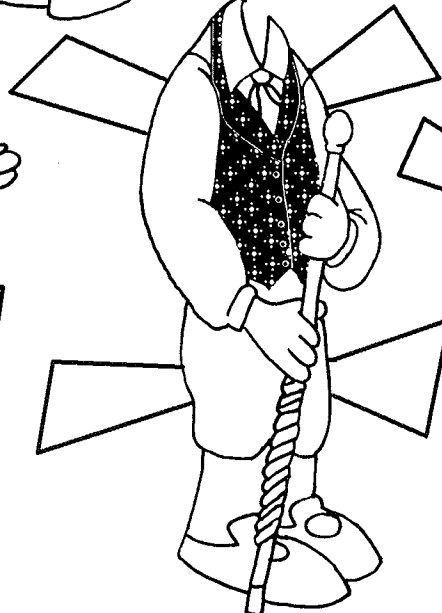
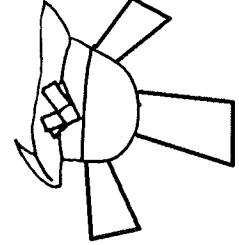
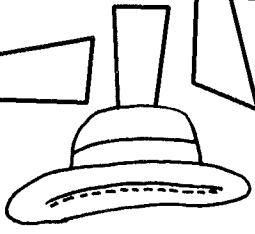
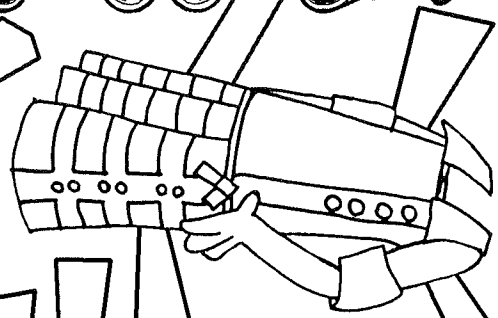

After we declared war on Germany, suspected German spies were nabbed in Butler and were never seen again.

Because of Butler's industrial boom, more workers were needed. Many eastern-European immigrants, escaping pre-WWI conditions, came to the U.S. and settled in Lyndora to be near employment.

TROLLEY CARS COULD BE RENTED FOR FUNERALS TO CLIMB NORTH MAIN ST. HILL AND BUTLER BECAME A THIRD CLASS CITY.

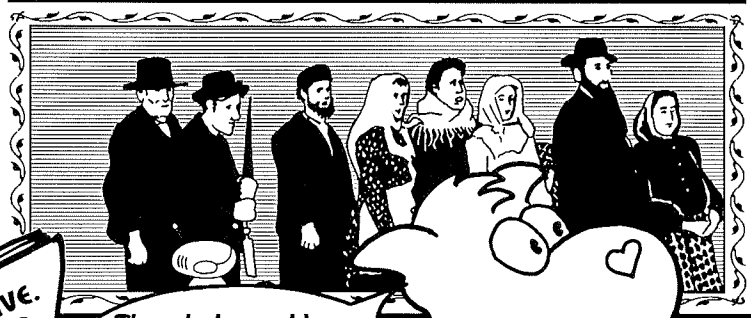

The whole world was a mess -- people even saved their fruit pits to make gas masks for the war effort.

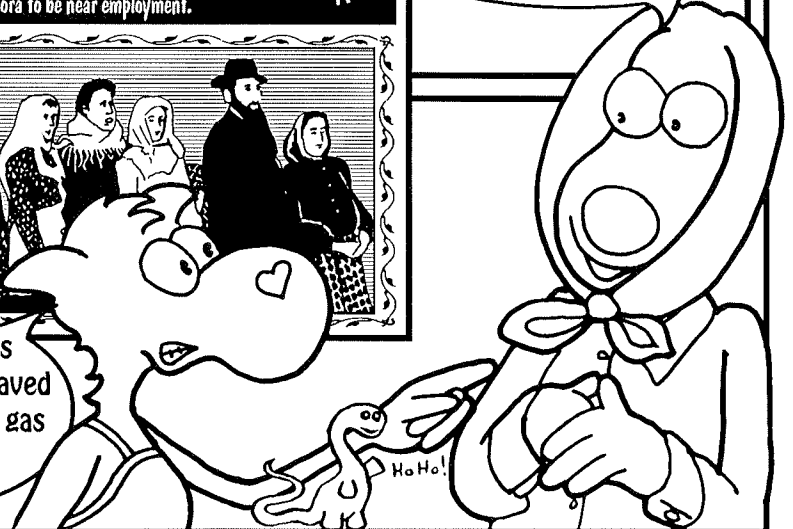

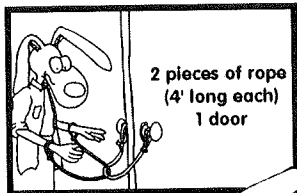
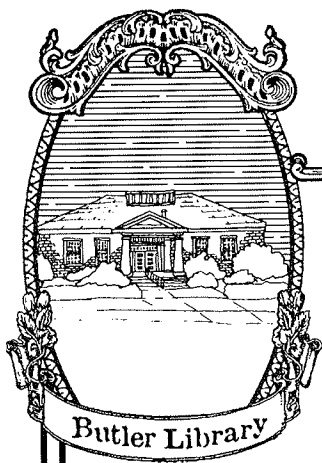

2 pieces of rope
(4' long each)
1 door

The goal is to
escape without
cutting or breaking
the rope.

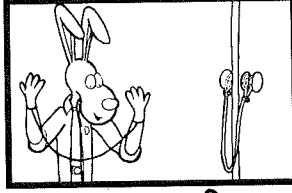

Can you
escape like
Houdini?

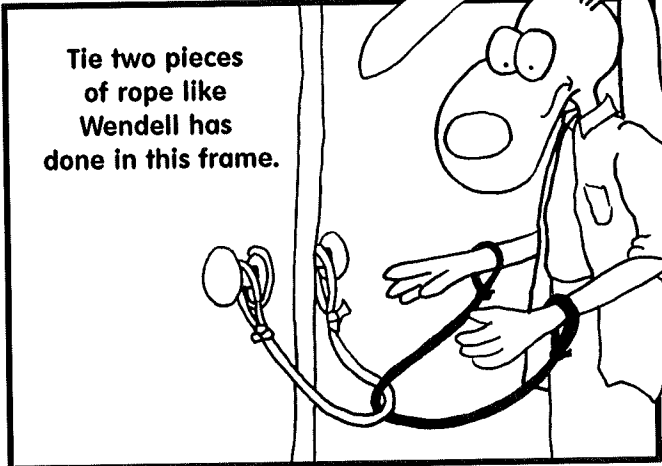

Tie two pieces
of rope like
Wendell has
done in this frame.

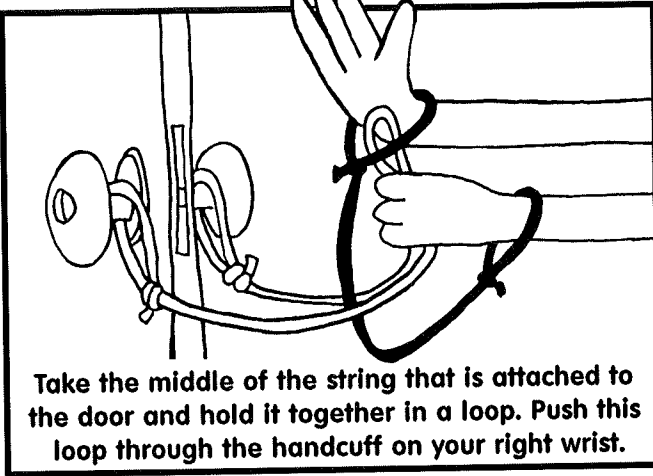

Take the middle of the string that is attached to the door and hold it together in a loop. Push this loop through the handcuff on your right wrist.

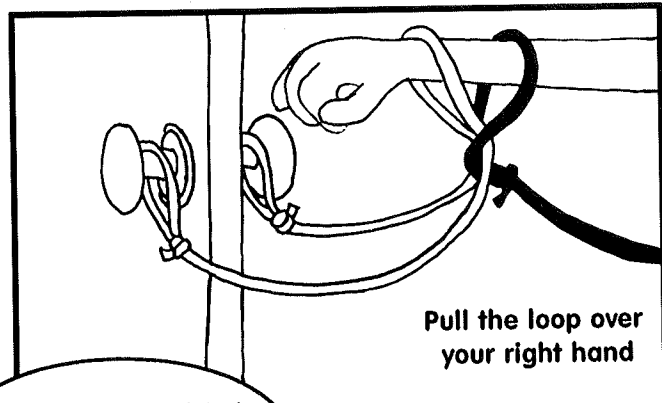

Pull the loop over
your right hand

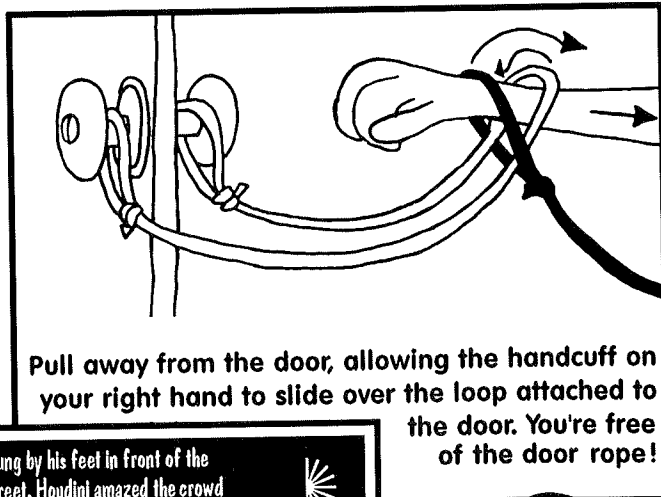

Pull away from the door, allowing the handcuff on your right hand to slide over the loop attached to the door. You're free of the door rope!

I'll bet Henry Blakely would have liked Houdini to help him escape from the electric chair.

Around 1929, Harry Houdini hung by his feet in front of the Capitol Theater on South Main Street. Houdini amazed the crowd with magic, illusion and escape tricks.

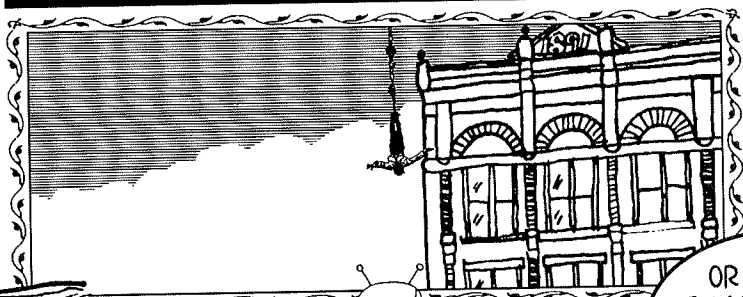

COUNTERFEITERS
NABBED

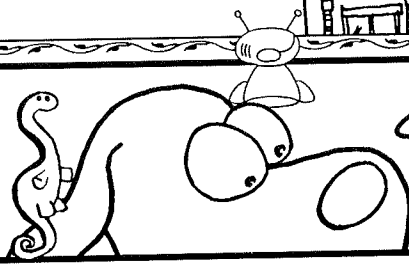

OR MAGICALLY
REPLACE THE BROKEN
GLASS FROM THE
NITROGLYCERIN
EXPLOSION.



I read every
house in Butler
felt that blast!



Can you copy the squares to their proper place on the grid?

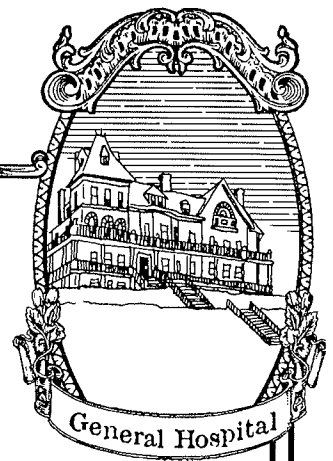

	1	2	3	4	5	
A						A
B						B
C						C
D						D
E						E
F						F
G						G
	1	2	3	4	5	

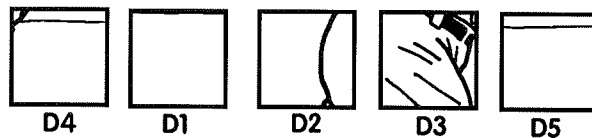
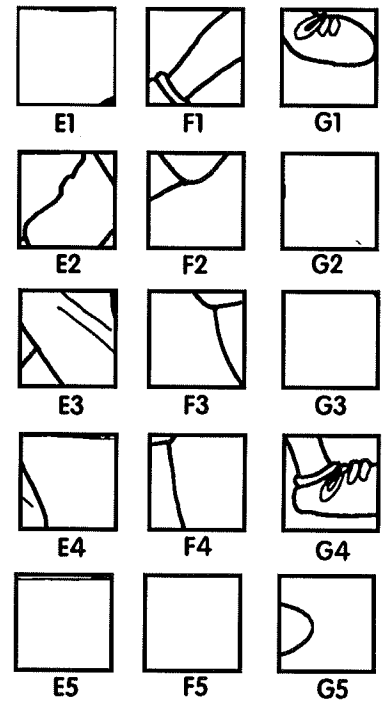
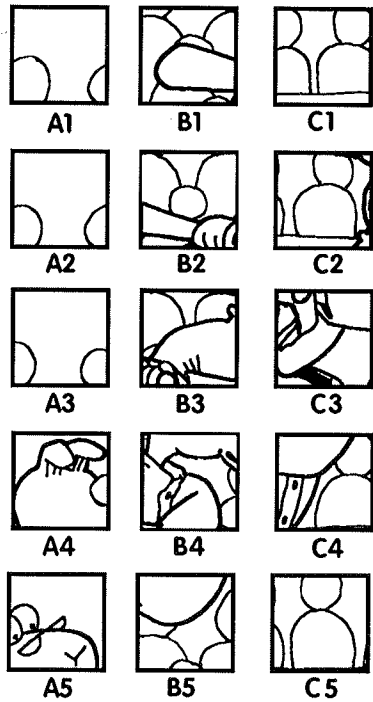

One year the game went unfinished because so many fans rushed the field for autographs!

In 1936, the New York Yankees sponsored a farm team known as the Butler Yankees. The Butler Yankees refined the talents of Whitey Ford and Joe Page. Even Joe DiMaggio and Lou Gehrig played at Pullman Park!

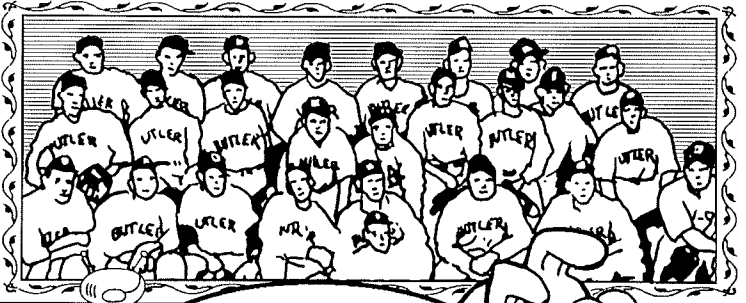

I WONDER IF THEY PRACTICED WITH ANY OF THE 14,000 DOZEN EGGS FROM THE EAST BUTLER AUCTION.



Too bad "Rube" Waddell didn't play then. It would've been great to see a left-handed pitcher strike out 16 batters in one game!

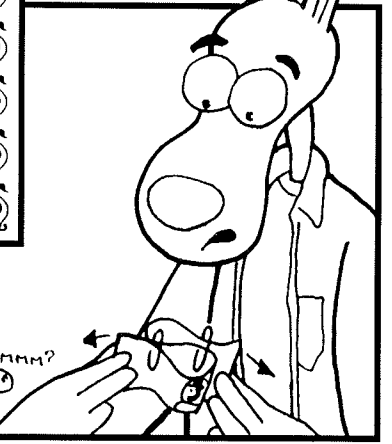

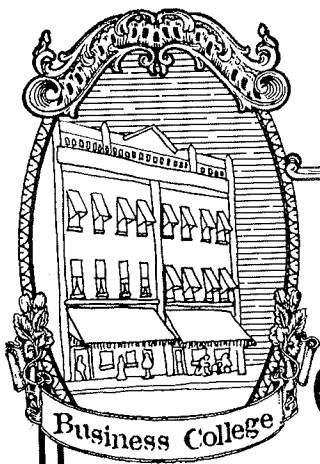

Hey! You can make your own Jeep!

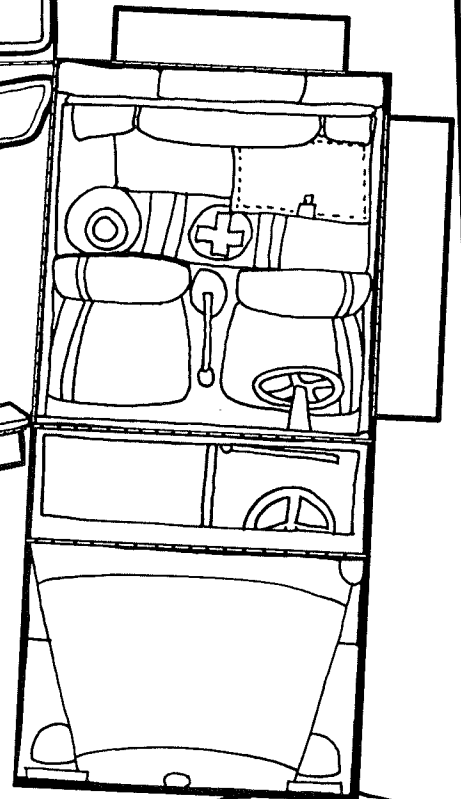
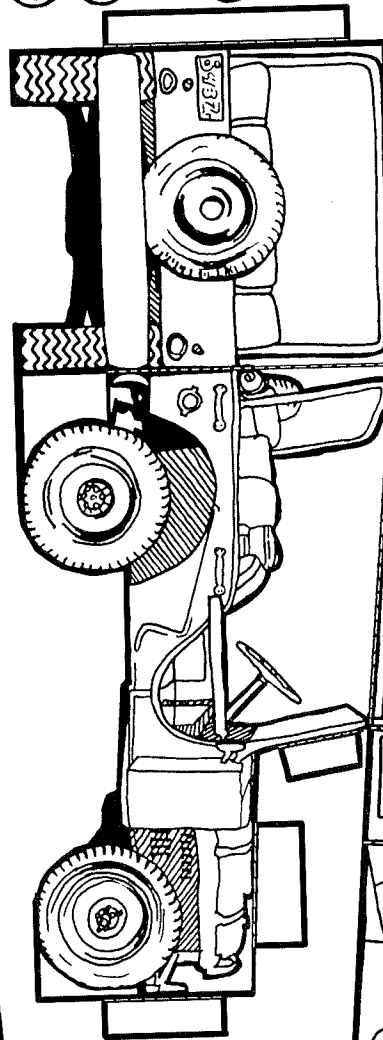
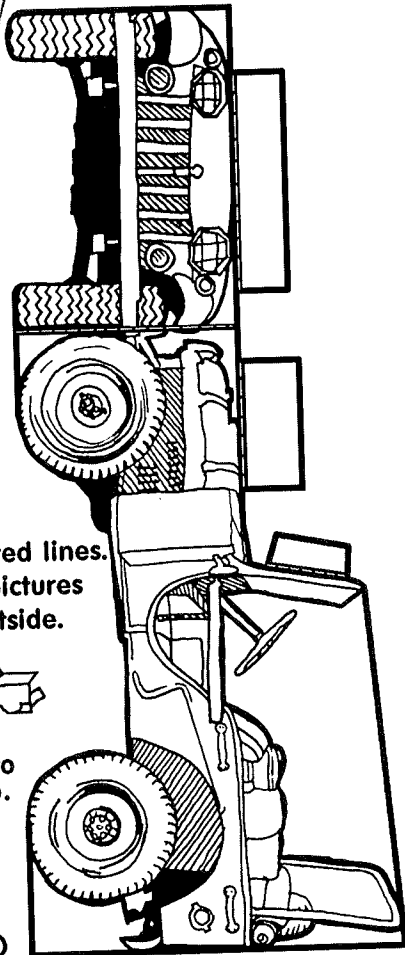
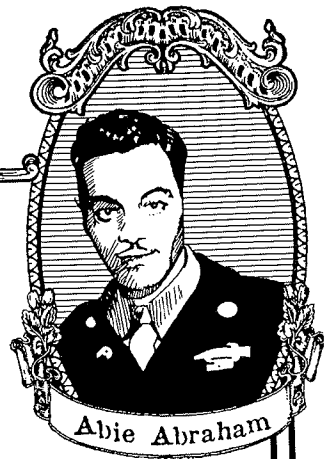

1. Cut on the solid lines.

2. Fold on the dotted lines. Make sure the pictures are on the outside.

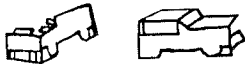

3. Glue tabs to form a Jeep.

IT WASN'T UNTIL 1948 THAT BUTLER GOT CREDIT FOR INVENTING THE JEEP.

In 1940, the first Jeep was produced. The Bantam Jeep had four-wheel drive and could climb a 45° hill with power to spare. Due to increased demands for faster production, the contract was lost and others claimed they invented the Jeep.

Butler had another first when Joy Coates became the first woman to join the U.S. Army in WWII.

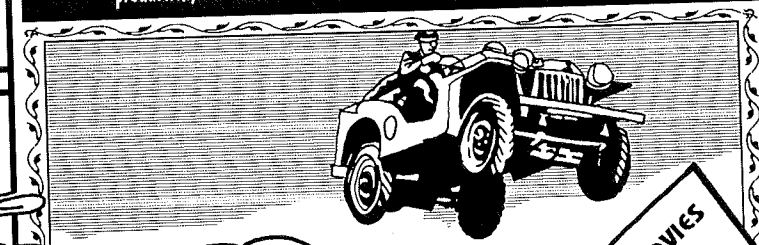

SUNDAY MOVIES OUTLAWED

Don't forget Butler also produced the Standard Eight Touring Car and the Austin!



Arthur Ripper



1950's

Can you put these triangle shapes together to form a "glacier."

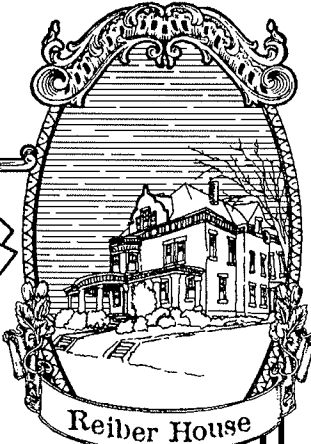

Reiber House

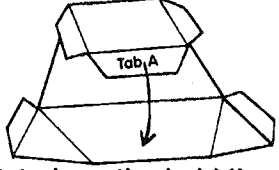

Cut along the bold lines
Fold along the dotted lines.
Glue tab A to opposite side

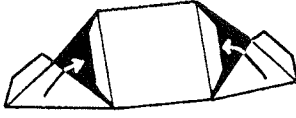

Fold sides up and
glue into place.



You will have
two identical
triangle shapes.

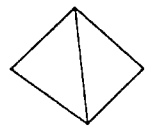
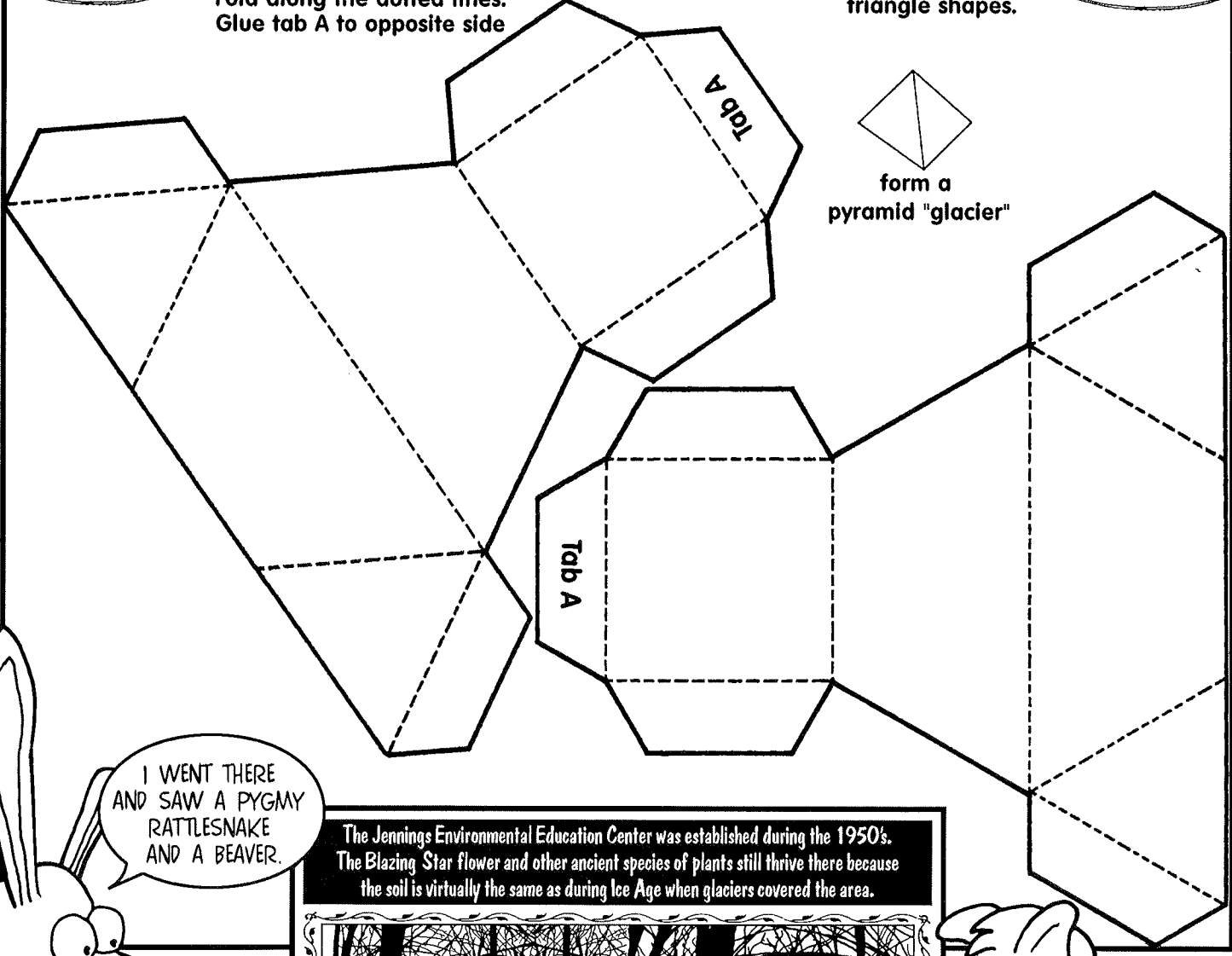

form a
pyramid "glacier"



I WENT THERE
AND SAW A PYGMY
RATTLESNAKE
AND A BEAVER.

The Jennings Environmental Education Center was established during the 1950's.
The Blazing Star flower and other ancient species of plants still thrive there because
the soil is virtually the same as during Ice Age when glaciers covered the area.



We learned about the
river otter, black bear and
coyote that live there in
their natural habitat.

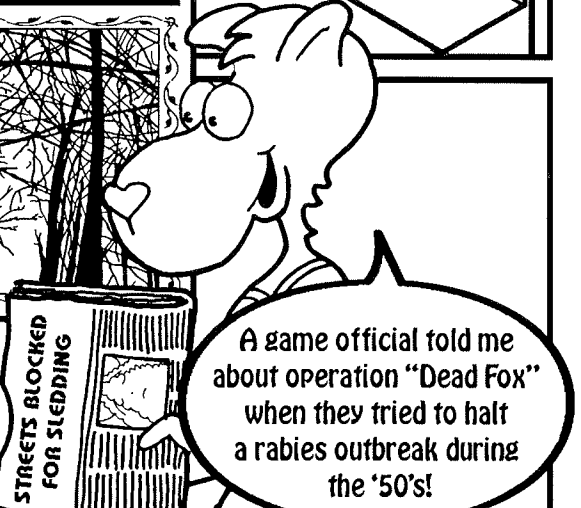

A game official told me
about operation "Dead Fox"
when they tried to halt
a rabies outbreak during
the '50's!

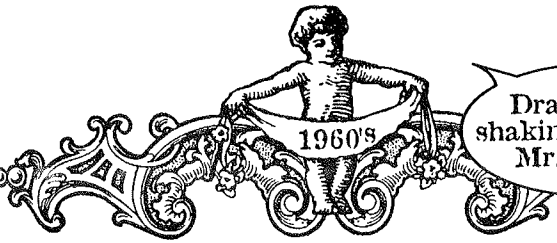
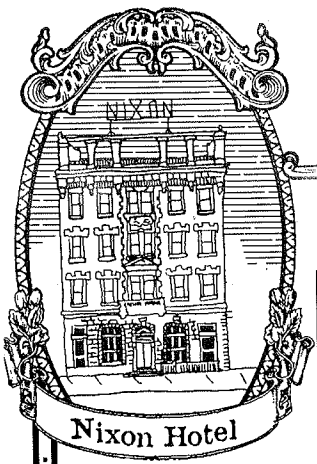

Draw yourself shaking hands with Mr. Kennedy!

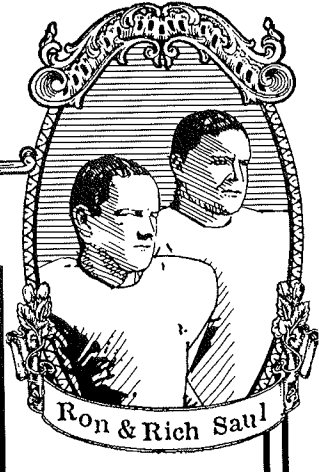

On October 15, 1960, John F. Kennedy visited Butler during his campaign for President. As Kennedy addressed the crowd from the courthouse, a "Nixon Hotel renamed Nixon Lodge" sign could be seen. A little more than a month later, JFK was elected the 35th President of the United States.

Republican ticket: Richard Nixon and Henry Cabot Lodge

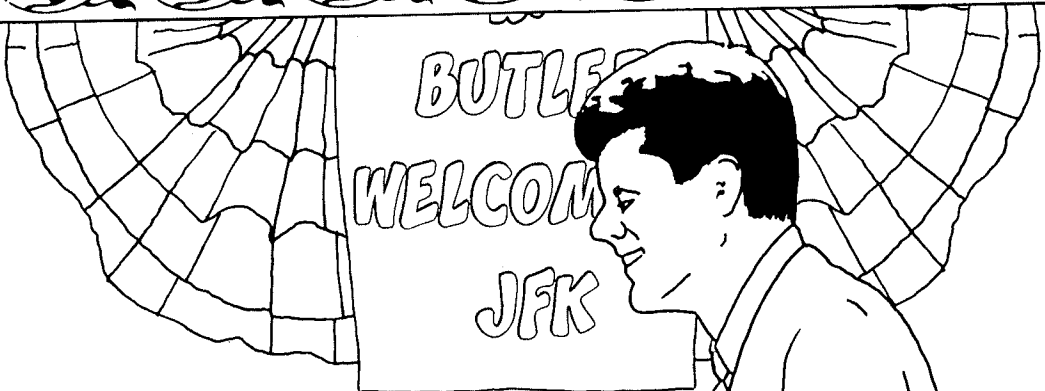

Years later, Hubert Humphrey retraced Kennedy's steps through Butler.

THIS DECADE BROUGHT THE FIRST CHRISTMAS PARADE, AND THE MUSIC AND ARTS FESTIVAL TO BUTLER.

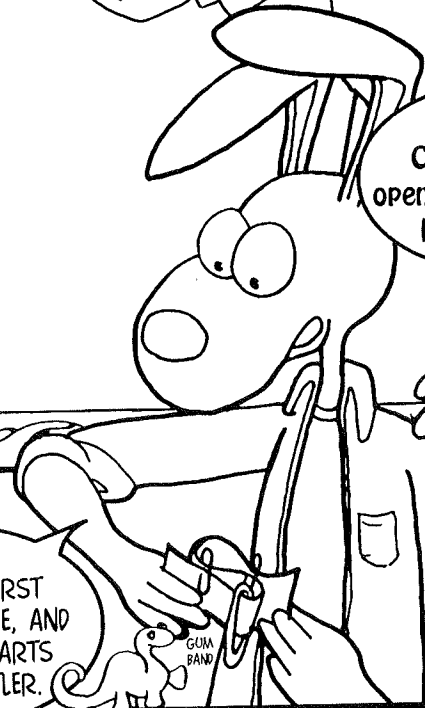

Butler County Community College opened, and the Old Stone House was saved.







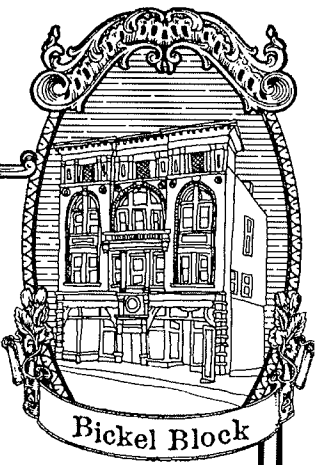







Can you pick up these sticks?



Mentally, pick up these sticks with animal tracks on them. The Cat print is first. Can you guess which one is next until they are all picked up?

- 
Fox
- 
Rabbit
- 
Raccoon
- 
Deer
- 
Mouse
- 
Skunk
- 
Opossum
- 
Squirrel
- 
Cat
- 
Otter

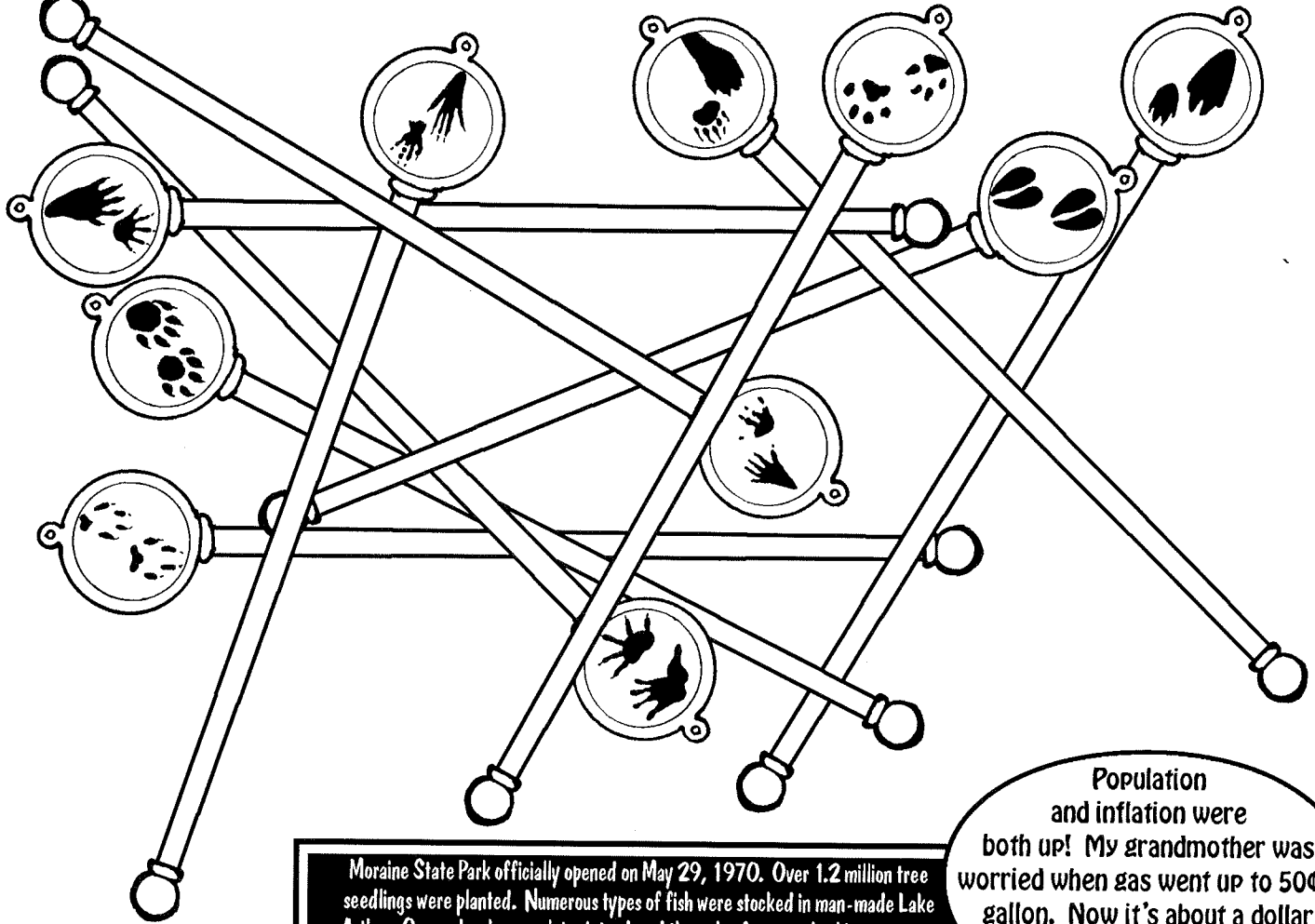

Moraine State Park officially opened on May 29, 1970. Over 1.2 million tree seedlings were planted. Numerous types of fish were stocked in man-made Lake Arthur. Osprey hawks were later introduced through a four year hacking program.

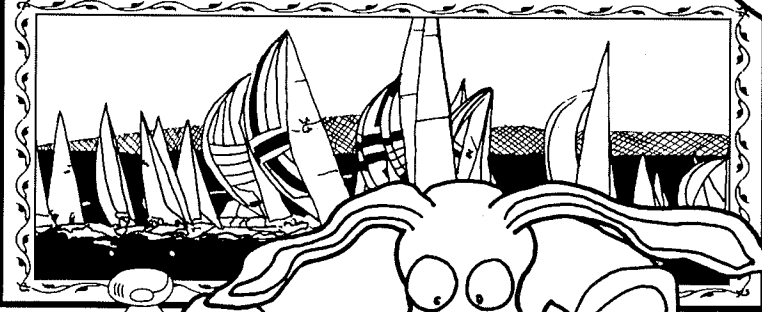

Population and inflation were both up! My grandmother was worried when gas went up to 50¢ a gallon. Now it's about a dollar more and my parents are having fits!

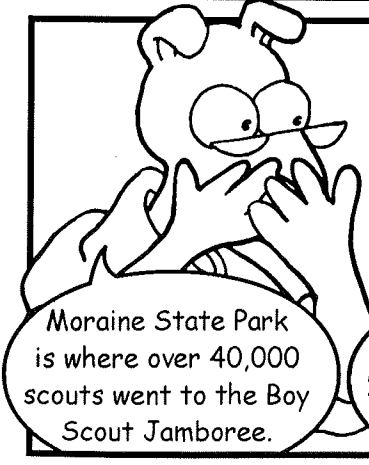

Moraine State Park is where over 40,000 scouts went to the Boy Scout Jamboree.

WOW! THAT'S MORE THAN ALL THE PEOPLE IN CRANBERRY. THEY ONLY HAD AROUND 9,000 PEOPLE IN 1976.

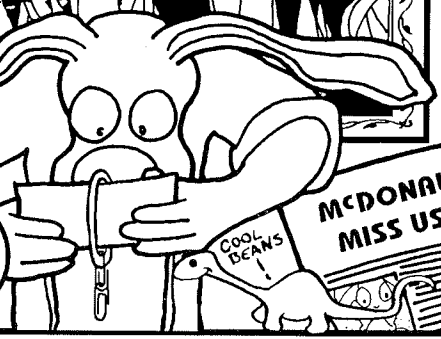

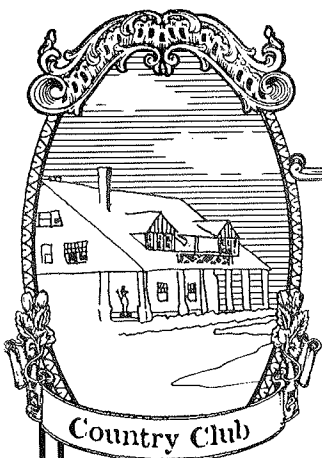

Country Club



Here's a fun puzzle for you!



Marian Taylor

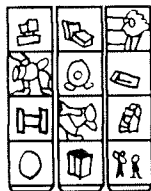

1. Cut on the solid lines. You will end up with three strips.



2. Fold on the dotted lines. Make sure the pictures are on the outside.

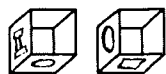

3. Glue strips A and C into cubes.

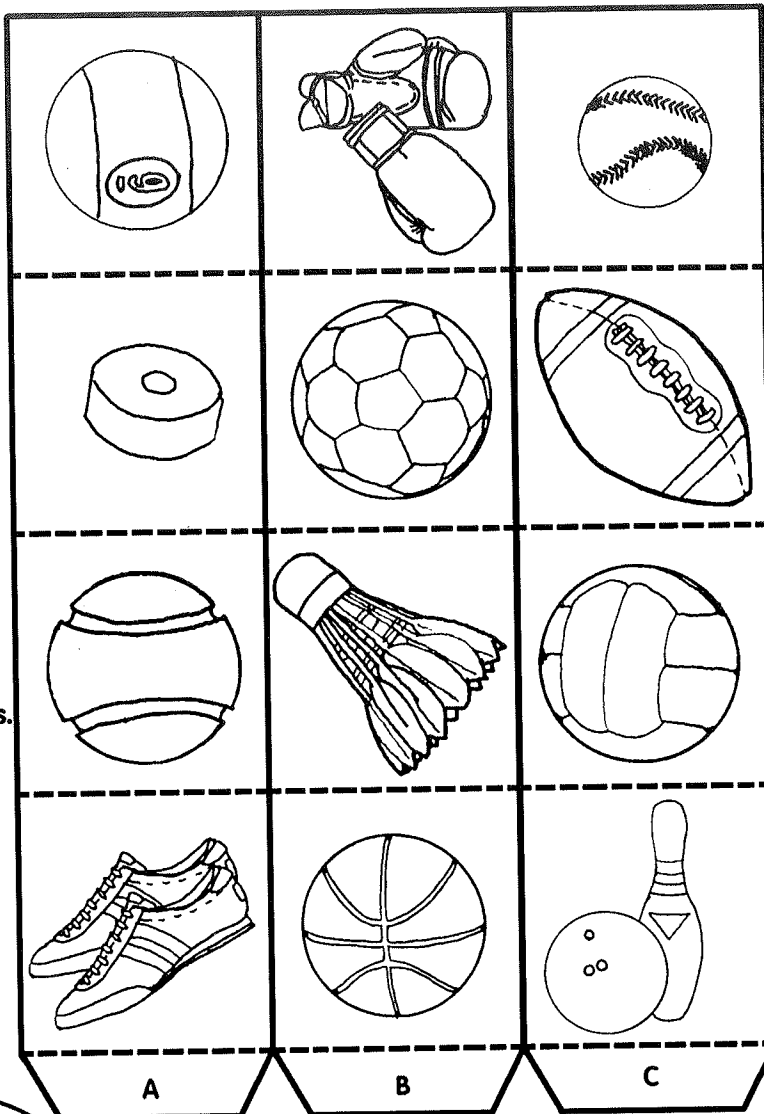

4. Loop strip B through A and C and glue.



5. You should have something that looks like a chain with three links.



6. Now comes the trick form a cube. Have fun!

WHAT ABOUT BIG JOHN STUDD? DO YOU THINK HE'D GET MAD IF WE CALLED HIM SUNFLOWER LIKE HIS HIGH SCHOOL COACH DID?

Butler has produced some great athletes including:

John Stuper ♦ St. Louis Cardinal pitcher ♦ 1983 World Series Ring
 Terry Hanratty ♦ Pittsburgh Steelers ♦ Super Bowls IX and X
 Eric Namesnik ♦ Olympic Silver Medals 1992 and 1996
 Jim Simons ♦ PGA ♦ Butler Country Club Golf Course record of 63
 Matt Clement ♦ Pitcher ♦ San Diego Padres!

Or get help from The First Ward Running Team of 1893. They pulled a 600lb. hose cart and set a record of 32 seconds.

Probably! We'd have to call the Saul brothers to help us. All three played professional football!

GIGGIE!
 GIGGIE!
 GIGGIE!



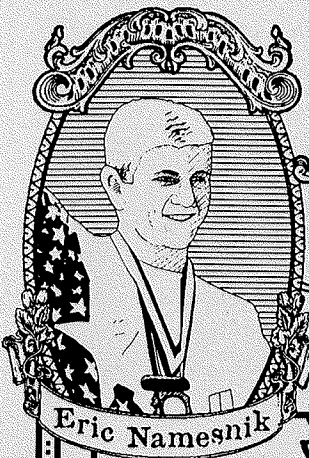

Eric Namesnik



drill with 1/4 inch bit



large balloon

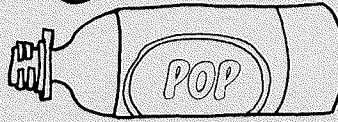

1 liter plastic bottle

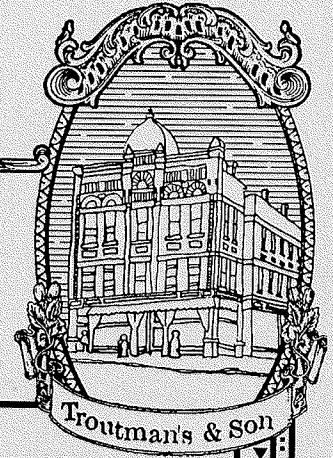

Troutman's & Son

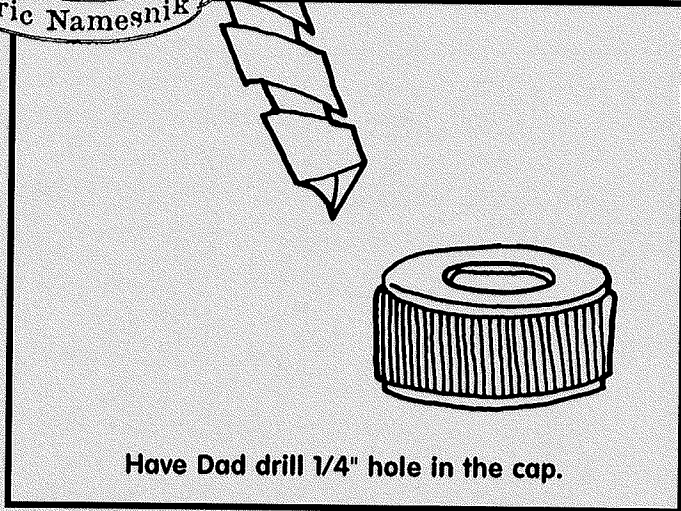

Have Dad drill 1/4" hole in the cap.

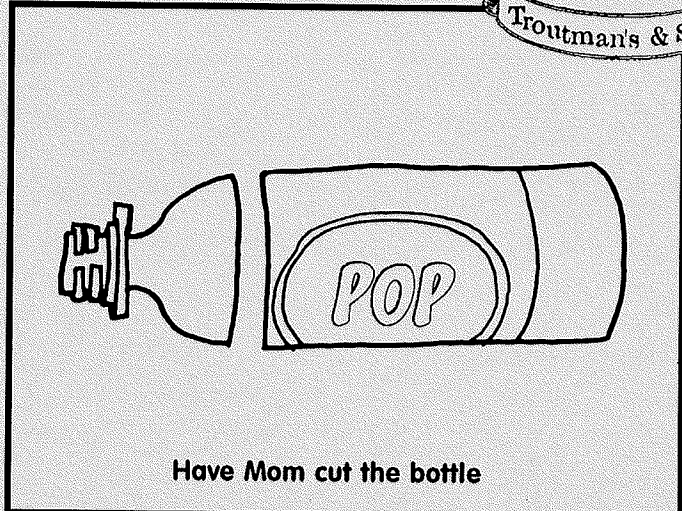

Have Mom cut the bottle



BONUS TOY:
Keep pencils in bottom!



Put cap on and sand end flat.

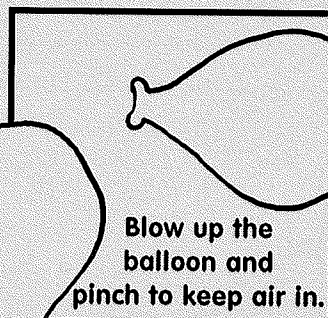

Blow up the balloon and pinch to keep air in.

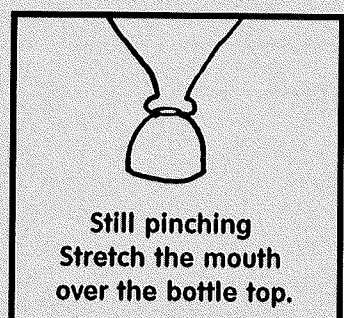

Still pinching
Stretch the mouth over the bottle top.

Let it go on a flat surface.

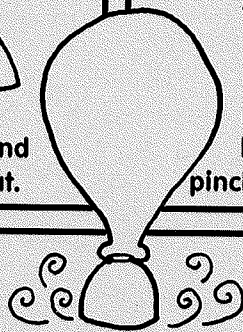

Push gently and it should glide around the table.

THE ICE STORMS ALMOST COLLAPSED THE ROOF OF THE SENIOR HIGH GYM, PULLED DOWN TELEPHONE POLES, AND SCHOOL WAS CANCELED. IT WAS SOOO COOL!

Butler prepared for the 21st century with curbside recycling. Careful preparation caused Y2K to result in a non-event. The Storm of the Century buried Butler under inches of ice.

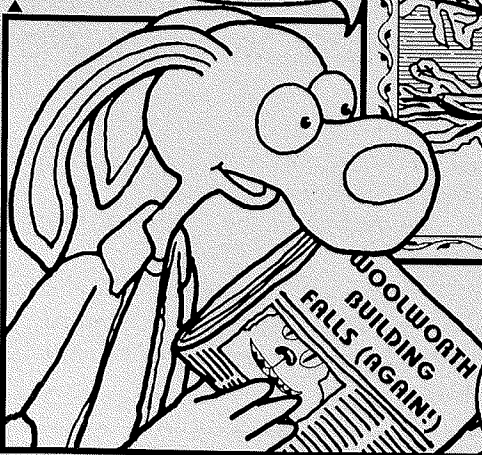

WOOLWORTH BUILDING FALLS (AGAIN!)

A Worthington couple won a cool \$10 million. They're set for the future!

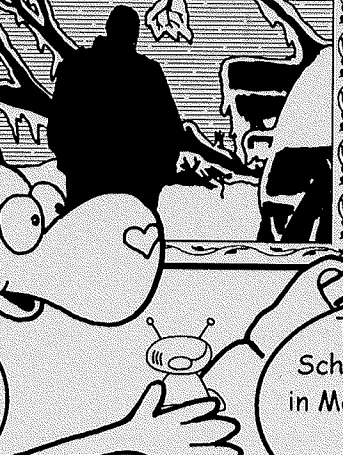

The Butler High School Band marched in Macy's Thanksgiving Day Parade.

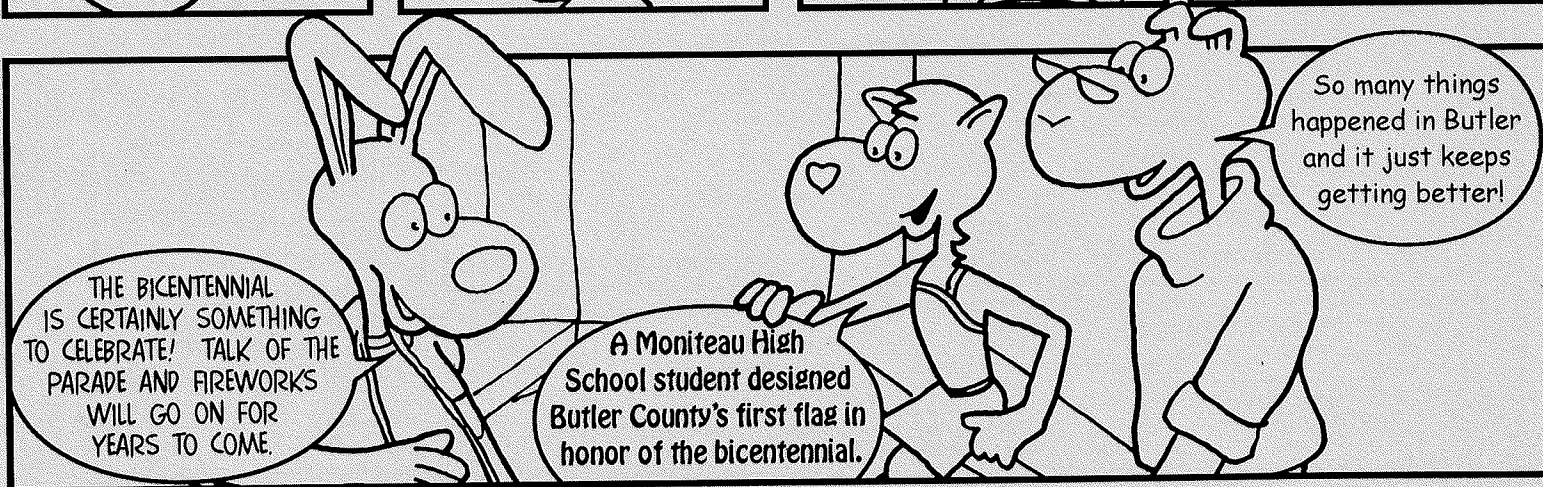
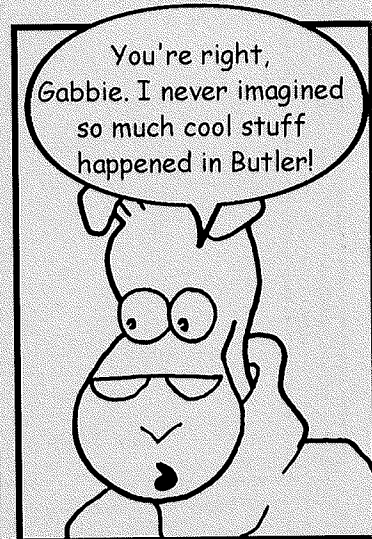
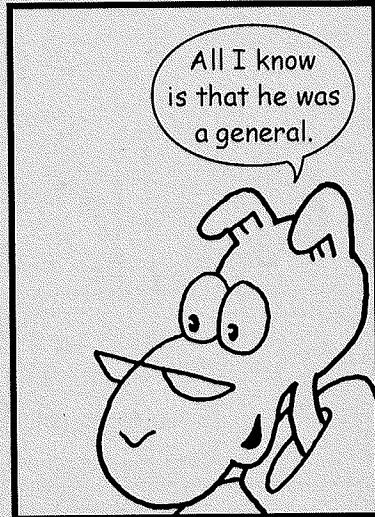
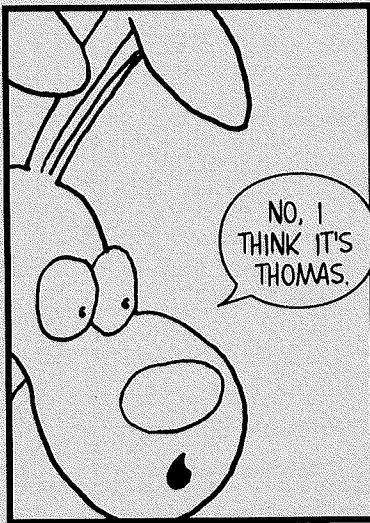
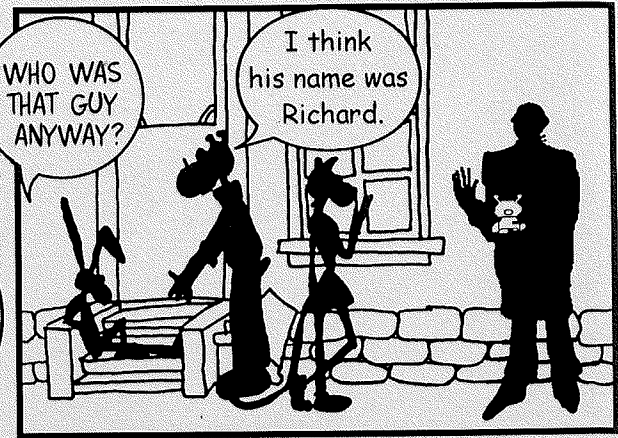
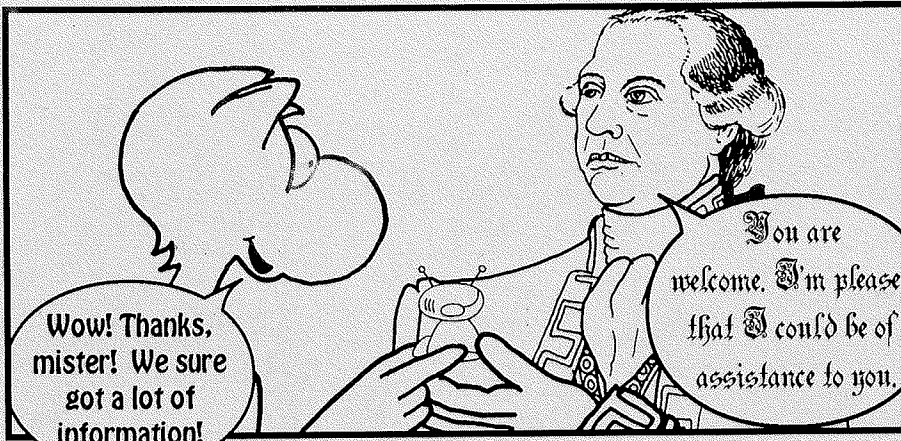

You can find out more information about the headlines and conversations of Gabbie, Kermit, and Wendell at the library and the Butler County Chamber of Commerce & Tourism.

Here are the books we used:

Ralph Goldinger and Audrey Feters
Butler County: The Second Hundred Years.

Stephen M. Pozar and Jean B. Purvis
Butler: A Pictorial History
 Virginia Beach: Donning Company Publishers, 1980.

James Clements
**Favorite Sons and Sons of Guns
 or Butler: The Untold Stories**
 The Golden Tornado Foundation, Inc., 1997.

James Clements
**Builders, Dreamers, Scandals, Schemers
 or Who Said Nothing Ever Happened In Butler?**
 The Golden Tornado Foundation, Inc., 1994.